



ibaBM-ENetIP

EtherNet/IP Busmonitor

Manual

Issue 1.3

Measurement Systems for Industry and Energy
www.iba-ag.com

Manufacturer

iba AG
Koenigswarterstr. 44
90762 Fuerth
Germany

Contacts

Main office +49 911 97282-0
Fax +49 911 97282-33
Support +49 911 97282-14
Engineering +49 911 97282-13
E-Mail: iba@iba-ag.com
Web: www.iba-ag.com

This manual must not be circulated or copied, or its contents utilized and disseminated, without our express written permission. Any breach or infringement of this provision will result in liability for damages.

©iba AG 2021, All Rights Reserved

The content of this publication has been checked for compliance with the described hardware and software. Nevertheless, deviations cannot be excluded completely so that the full compliance is not guaranteed. However, the information in this publication is updated regularly. Required corrections are contained in the following regulations or can be downloaded on the Internet.

The current version is available for download on our web site <http://www.iba-ag.com>.

Windows® is a label and registered trademark of the Microsoft Corporation. Other product and company names mentioned in this manual can be labels or registered trademarks of the corresponding owners.

Certification

The device is certified according to the European standards and directives. This device corresponds to the general safety and health requirements. Further international customary standards and directives have been observed.



Issue	Date	Revision	Chapter	Author	Version HW / FW
1.3	02-2022	Sniffer decoder module	9.2.3		

Table of contents

1	About this manual	5
1.1	Target group.....	5
1.2	Notations.....	5
1.3	Used symbols.....	6
2	Introduction	7
3	Scope of delivery	8
4	Safety instructions	9
4.1	Designated use	9
4.2	Special safety instructions	9
5	System requirements	10
5.1	Hardware	10
5.2	Software.....	10
6	Mounting and dismantling	11
6.1	Mounting	11
6.2	Dismounting	11
7	Device description	12
7.1	Device views	12
7.2	Indicating elements	13
7.3	Operating elements, connections	14
7.3.1	Fiber optic connections X10 and X11	14
7.3.2	Voltage supply X14.....	14
7.3.3	Pushbutton S10.....	14
7.3.4	Rotary switch S2	15
7.3.5	TAP interface X42	15
7.3.6	Service interface X12	15
7.3.7	Monitor interface X13	15
7.3.8	Shield connector X29	15
8	System integration	16
8.1	Data acquisition with TAP interface / Sniffer	16
8.2	32Mbit Flex protocol and ibaFOB-D network	16
8.2.1	Data amount and sampling rate.....	16
8.2.2	Ring topology	17
9	Configuration with ibaPDA	19
9.1	First steps for the configuration in ibaPDA.....	19
9.2	Modules in the I/O Manager	23
9.2.1	"ibaBM-ENetIP" device module	23
9.2.2	"EtherNet/IP sniffer" module	28
9.2.3	"EtherNet/IP sniffer decoder" module	32
9.3	Calculation of the telegram size with 32Mbit Flex	35
10	EtherNet/IP engineering	37
10.1	Operation as sniffer	37

11	Technical data	38
11.1	Main data	38
11.2	Dimensions	40
11.3	Example for FO budget calculation	41
12	Support and contact	43

1 About this manual

This manual describes the construction, the use and the operation of the ibaBM-ENetIP device.

1.1 Target group

This manual addresses in particular the qualified professionals who are familiar with handling electrical and electronic modules as well as communication and measurement technology. A person is regarded to as professional if he/she is capable of assessing safety and recognizing possible consequences and risks on the basis of his/her specialist training, knowledge and experience and knowledge of the standard regulations.

1.2 Notations

The following designations are used in this manual:

Action	Notations
Menu command	Menu <i>Logic diagram</i>
Call of menu command	<i>Step 1 – Step 2 – Step 3 – Step x</i> Example: Select menu <i>Logic diagram – Add – New logic diagram</i>
Keys	<Key name> Example: <Alt>; <F1>
Press keys simultaneously	<Key name> + <Key name> Example: <Alt> + <Ctrl>
Buttons	<Button name> Example: <OK>; <Cancel>
File names, Paths	„File name“, „Path“ Example: „Test.doc“

1.3 Used symbols

If safety instructions or other notes are used in this manual, they mean:



⚠ DANGER

The non-observance of this safety information may result in an imminent risk of death or severe injury:

- By an electric shock!
- Due to the improper handling of software products which are coupled to input and output procedures with control function!

If you do not observe the safety instructions regarding the process and the system or machine to be controlled, there is a risk of death or severe injury!



⚠ WARNING

The non-observance of this safety information may result in a potential risk of death or severe injury!



⚠ CAUTION

The non-observance of this safety information may result in a potential risk of injury or material damage!



Note

A note specifies special requirements or actions to be observed.



Tip

Tip or example as a helpful note or insider tip to make the work a little bit easier.



Other documentation

Reference to additional documentation or further reading.

2 Introduction

EtherNet/IP (EtherNet Industrial Protocol) is a real-time Ethernet which is mainly used in automation technology.

The EtherNet/IP bus monitor ibaBM-ENetIP is a device for acquiring the cyclical data exchange between EtherNet/IP scanner (master) and adapters (slaves). The device can be integrated into an existing EtherNet/IP network with one or more EtherNet/IP scanners (master).

The ibaBM-ENetIP bus monitor can be operated in an EtherNet/IP network without interferences using the TAP interface (Ethernet). The device works as sniffer, i.e. it listens to the cyclic data exchange of the IO data (implicit messaging) between EtherNet/IP scanner (master) and adapters (slaves).

The entire communication via the TAP interface is being mirrored to a monitor port and can be recorded using an external network analysis tool.

On the optical-fiber side, ibaBM-ENetIP works with the ibaNet protocol 32Mbit Flex. With this protocol, measuring and configuration data are transferred via a bidirectional fiber optic connection. The sampling rate and the data formats can be configured flexibly.

Overview of the most important characteristic values:

- TAP interface for sniffer function
- Monitor interface for connecting a network analysis tool
- Data acquisition with ibaPDA
- Simple configuration and measurement via bidirectional FO connection with ibaNet protocol 32Mbit Flex
- Flexible configuration of sampling rate and data formats with 32Mbit Flex

Order data

Order no.	Product name	Description
13.120010	ibaBM-ENetIP	Bus module for acquiring data on EtherNet/IP networks

3 **Scope of delivery**

After having unpacked the delivery, please check if it is complete and intact.

The following components are included in delivery:

- ibaBM-ENetIP device

4 Safety instructions

4.1 Designated use

The device is an electrical equipment. It may only be used for the following applications:

- Measurement data acquisition and measurement data analysis
- Automation of industrial plants
- Applications of iba software products (e.g ibaPDA) and iba hardware products

The device may only be used as defined in the "Technical Data" chapter.

4.2 Special safety instructions



Warning!

This is a Class A device. This equipment may cause radio interference in residential areas. In this case, the operator will be required to take appropriate measures.

CAUTION

Observing the operating voltage range

The device should not be operated at voltages exceeding +24 V DC! An overly high operating voltage destroys the device and may result in death or serious injury.

CAUTION

Connecting and removing network cables

Changes in the EtherNet/IP network might have an impact on the functionality of the control system.

CAUTION

Do not open the device!

There are no serviceable parts inside the device.

Opening the device will void the warranty.



Note

Cleaning

To clean the device, use a dry or slightly moistened cloth.

5 System requirements

5.1 Hardware

- ibaBM-ENetIP, firmware beginning with version v01.02.001; hardware version beginning with version A1

For operation:

- 24 V DC voltage supply

For the device configuration and for measuring:

- PC as recommended for use with ibaPDA:
 - Multicore CPU 2 GHz, 2048 MB RAM, 100 GB HDD, or higher
 - At least one free PCI/PCIe slot (computer)

On our homepage <http://www.iba-ag.com> you find suitable computer systems with desktop and industry housing.

- At least one FO input and output card of the ibaFOB-D or ibaFOB-Dexp type or an ibaFOB-io-USB adapter
- One ibaNet FO patch cable for bidirectional connection of ibaBM-ENetIP and ibaPDA-PC
- EtherNet/IP network with EtherNet/IP scanner (master) and at least one EtherNet/IP adapter (slave)

5.2 Software

- ibaPDA / ibaQDR, Version 7.2.0 or higher

6 Mounting and dismounting

6.1 Mounting

1. Insert the DIN rail clip on the rear side of the device on top in the DIN rail, press the device down/back and let the DIN rail lock.
2. If there is the provision in the plant that the device has to be grounded, then connect the device to the ground (shield connector X29).
3. Once fixed, connect the 24 V DC power supply with the right polarity.
4. Connect FO cable to the ibaPDA system (bidirectional).
5. Connect the Ethernet cable

6.2 Dismounting

1. First of all, disconnect all connections that exist to the device.
2. Grasp the device with one hand firmly on the top side. For the device later lies firmly in your hands and does not fall to the floor, please press the device slightly down.
3. With the other hand, grasp the device on the bottom and pull it to the front/top. The device will get detached from the DIN rail.

7 Device description

7.1 Device views

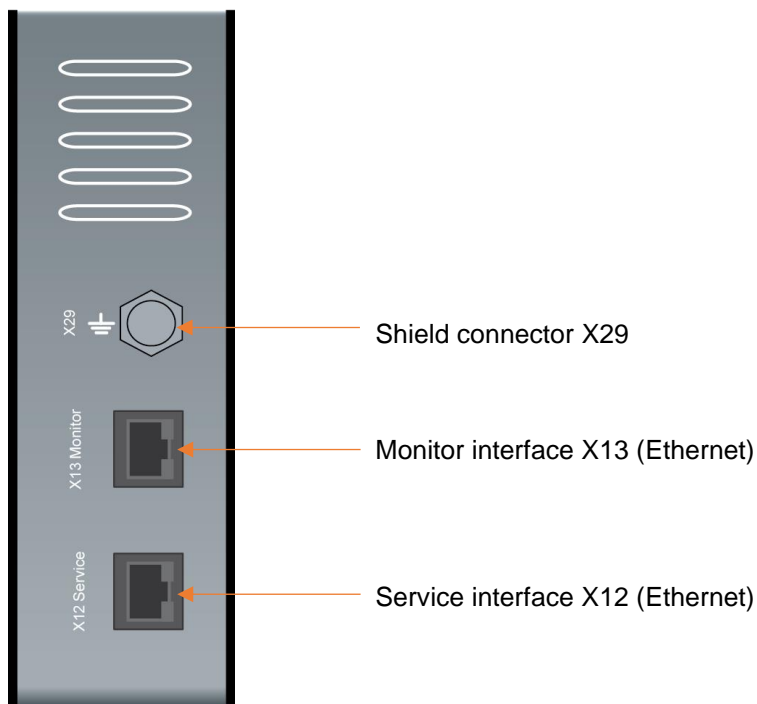
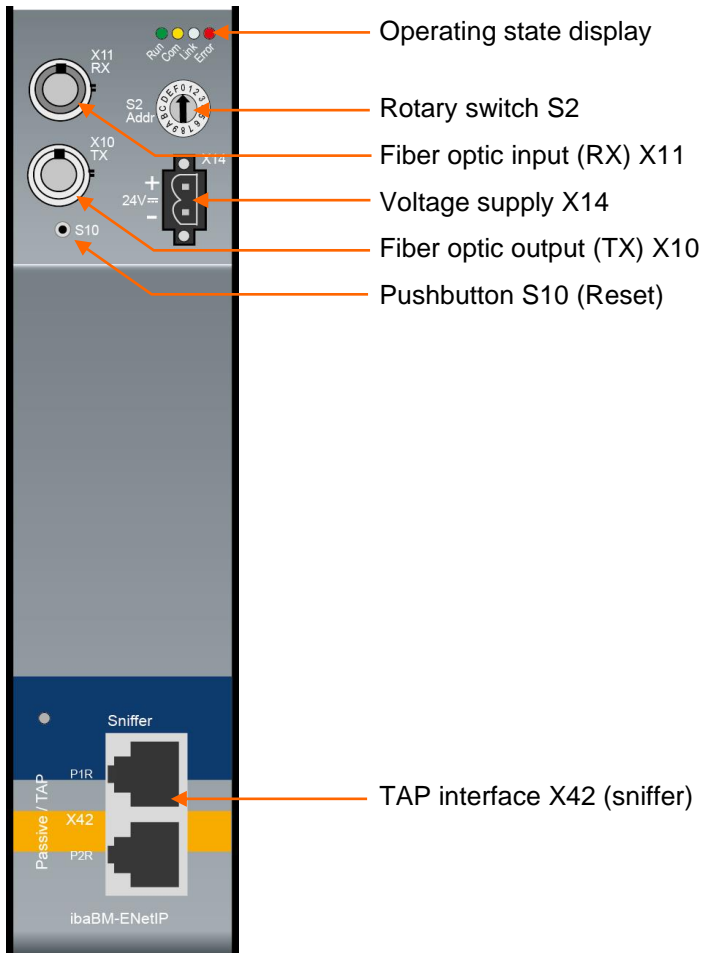

7.2 Indicating elements

On the device, colored light diodes (LED) show the operating status of the device.

Operating state

LED	State	Description
Run (green)	Blinking	Ready for operation, power supply connected
	Blinking rapidly	Update mode or reset to default settings (S10 pushbutton)
	On	Boot phase
Com (yellow)	Blinking	TCP/UDP/IP telegram detected via FO
Link (white)	Blinking	32Mbit input signal connected, but the device is not configured for this mode, S2 is on position 0
	On	Valid 32Mbit input signal detected
Error (red)	Blinking	Defect (configuration error)
	On	Hardware error

The operating status of the TAP interface “Sniffer” is indicated by multi-color LED.

Operating state of the TAP interface “Sniffer“

Color	State	Description
Green	On	Cyclic EtherNet/IP telegrams are detected and a configuration for the sniffer is active.
Green	Blinking	Cyclic EtherNet/IP telegrams are detected, but no configuration for the sniffer is active.
Yellow	On	Device is started but no cyclic EtherNet/IP telegrams are detected
Red	On	Hardware error

7.3 Operating elements, connections

7.3.1 Fiber optic connections X10 and X11

- ❑ X11 (RX): FO receiving interface
- ❑ X10 (TX): FO sending interface

On the ibaPDA system, a FO input/output card of the ibaFOB-D or ibaFOB-Dexp type or an ibaFOB-ioUSB adapter has to be installed for receiving and sending the data.

Maximum distance of fiber optic connections

The maximum distance of fiber optic connections between 2 devices depends on various influencing factors. This includes, for example, the specification of the fiber (e.g. 50/125 μm , 62.5/125 μm , etc.), or the attenuation of other components in the fiber optic cable plant such as couplers or patch panels.

However, the maximum distance can be estimated on the basis of the output power of the transmitting interface (TX) or the sensitivity of the receiving interface (RX). A model calculation can be found in chapter 11.3.

The specification of the transmitter's output power and the receiver's sensitivity of the fiber optic components installed in the device can be found in chapter 11.1 "Technical data" under "ibaNet interface".

7.3.2 Voltage supply X14

The ibaBM-ENetIP device has to be operated with an external DC voltage 24 V (unregulated) with a maximum current consumption of 400 mA. The operating voltage should be supplied using the 2-pin Phoenix screw connector included in delivery.

7.3.3 Pushbutton S10

With the S10 pushbutton, all settings can be reset to the factory settings:

1. Switch off the device.
2. Switch on the device with the pushbutton S10 keeping pushed.
3. Keep the pushbutton S10 pushed until the green LED "Run" of the operating status display starts blinking rapidly. Now, release the pushbutton.
4. When the green LED "Run" stops blinking rapidly, the factory settings have been applied. The device is immediately ready for operation and does not need to be switched off and on again.



Note

The device must not be switched off during the reset procedure.

7.3.4 Rotary switch S2

With the 32Mbit Flex protocol, up to 15 devices can be connected in a ring topology. The devices are addressed using the rotary switch S2.

Device number in the cascade	Position of the rotary switch
Not permitted	0
1. device	1
2. device	2
⋮	⋮
14. device	E
15. device	F

- Factory settings rotary switch position: 1

7.3.5 TAP interface X42

With the TAP interface, the device can be operated in an Ethernet network without any interferences. The whole data exchange can be recorded.

Communication via the TAP interface is maintained even if the power supply is interrupted.

7.3.6 Service interface X12

The Ethernet interface „X12 Service“ (RJ45) at the bottom of the device is designated for service purposes.

The Ethernet interface is set to a static IP address 192.168.1.1 which cannot be changed.

The service interface is not used at the moment.

7.3.7 Monitor interface X13

The Ethernet interface „X13 Monitor“ (RJ45, 1Gbit/s, no autonegotiation) at the bottom of the device is designated for connecting a network analysis tool like e.g. Wireshark¹. The communication via the TAP interface is mirrored and output on the X13 Monitor interface.

7.3.8 Shield connector X29

Connector (screw) for connecting the protective ground. Depending on the configuration of the control cabinet, it might be necessary to connect the shields of the network cable to the shield connector X29. Use a M6 terminal for connecting purposes.

If the shields of the network cables have been connected yet to the protective ground of the control cabinet, also connect the shield connector X29 to the protective ground of the control cabinet.

¹ <https://www.wireshark.org/>

8 System integration

8.1 Data acquisition with TAP interface / Sniffer

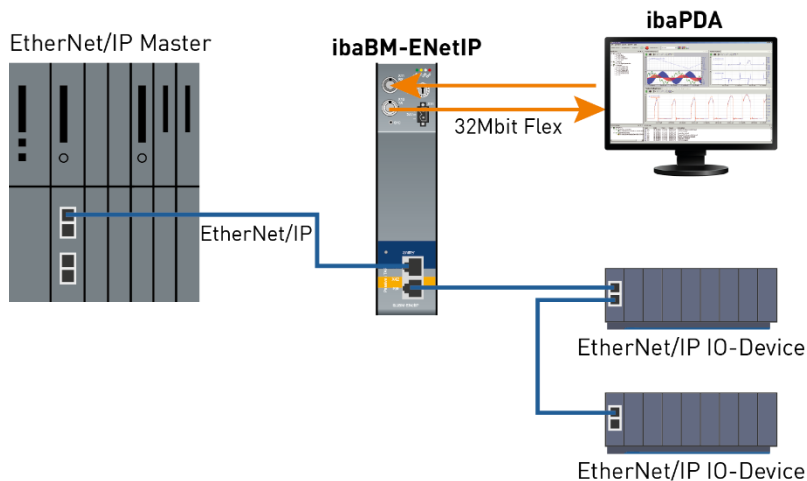

In the above example, the TAP interface is used for acquiring and analyzing the transferred data without interferences. It does not have to be integrated into the configuration of the EtherNet/IP scanner (master).

The point of installation within the EtherNet/IP network is relevant. The TAP interface always has to be integrated linearly. You can only acquire data which are transmitted at this position in the network.

It is therefore recommended to position the ibaBM-ENetIP directly next to the scanner (master).

8.2 32Mbit Flex protocol and ibaFOB-D network

The ibaNet 32Mbit Flex protocol (referred to as "Flex protocol") is a manufacturer-specific data transfer protocol by iba AG. This protocol serves to transfer measurement and configuration data via FO connections between different iba devices. The PC cards of the ibaFOB-D/ibaFOB-Dexp series and the ibaFOB-io-USB adapter as well as some devices for data acquisition support this protocol.

8.2.1 Data amount and sampling rate

The Flex protocol works with a data transfer rate of 32 Mbit/s and supports up to 15 "Flex-capable" devices connected in a ring topology.

With 32Mbit Flex, the data amount and the sampling rate can be flexibly customized. The data amount transferred per cycle depends on the sampling rate. Generally, the following applies: The less data are transferred, the higher is the possible sampling rate.

For the signals to be measured, sampling rates of 500 Hz to 100 kHz can be realized, which correspond to a timebase from 10 μ s up to 2 ms. The maximum sampling rate also depends on the acquisition device and can be found in the device manual. In ibaPDA you can select even smaller sampling rates down to 1 Hz. This corresponds to a timebase of 1000 ms. In this case, the timebase in the Flex ring is set to 2 ms and in ibaPDA a subsampling is carried out. Redundant data is discarded by ibaPDA.

With 32Mbit Flex, up to 4060 Bytes per cycle can be acquired and recorded depending on the sampling rate.

For the max. possible data amount of 4060 Bytes, the cycle time (timebase) is up to 1.4 ms. In the following table, you find reference values for the relation between cycle time and the max. transferable data amount per cycle.

Timebase	Max data amount
1.4 ms	4060 Bytes
1.0 ms	3100 Bytes
0.5 ms	1540 Bytes
0.025 ms	64 Bytes

To acquire further samples, especially if several devices are connected in a Flex ring topology, iba recommends using the simulator integrated in ibaPDA, see chapter 9.3.

The following data types are supported: BYTE, WORD, DWORD, INT, DINT, FLOAT and DOUBLE in Big/Little Endian format. These data amounts represent the limit values for the overall data amount on a Flex ring that can be transferred via an FO link.

8.2.2 Ring topology

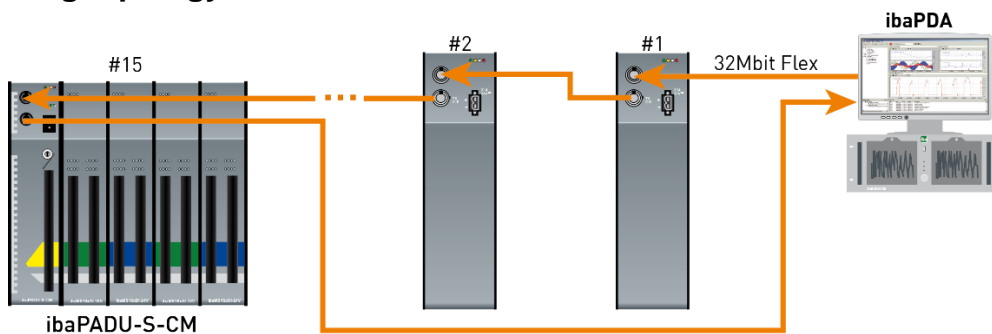

In a ring with 32Mbit Flex protocol, up to 15 devices can be connected. In the ring, all configuration and process data are transmitted.

ibaPDA automatically detects the devices in the ring and automatically determines the maximum possible sampling rate, depending on the type and number of the devices.

In the ring, also other 32Mbit Flex capable iba devices can be integrated, e. g. ibaPADU-S-CM like in the example above. The devices in the ring are addressed using the rotary switch for the device address (rotary switch S2 for ibaBM-ENetIP).

The individual device in the cascade can work with different access cycles. However, these cycles have to be an integer multiple of the smallest cycle; e.g. device #1 works with 0.5 ms, device #2 with 1 ms, device #3 with 4 ms, etc. If the max. data rate is exceeded, ibaPDA issues an error message that advises you to enhance the timebase and decrease the data amount.

The calculation of the maximum data amount is based on the fastest device in the ring. i.e. an increase of the cycle time of slow devices in the ring does not lead to an increased data transfer. Only when the cycle time of the fastest device in the ring is increased, the data amount can be increased.

➤ For further information about the distribution of the data amount in the Flex ring, please see chapter 9.3.

**Note**

Due to the large data amounts which are usually acquired with ibaBM-ENetIP, it is in most cases appropriate only to operate one device on a 32Mbit Flex link (see chapter 8.1).

9 Configuration with ibaPDA



9.1 First steps for the configuration in ibaPDA

With the following instructions, you integrate the ibaBM-ENetIP device stepwise as a sniffer in ibaPDA and configure the measurement signals.

1. Connect the device to a voltage source and switch on the device (see chapter 7.3.2).
2. Establish a FO connection between the TX connector of the device and a free RX input of an ibaFOB-D card as well as a FO connection between the RX connector and a free TX output of the ibaFOB-D card. The TX/RX connectors of the ibaFOB-D card belong together in pairs, i.e. you cannot use just any free TX/RX connectors.

Dark grey FO connectors are receiving **RX inputs**

Light grey FO connectors are sending **TX outputs**

3. Start the ibaPDA client  and open the I/O Manager .
4. On the left-hand side in the I/O Manager, the available system interfaces are displayed. Choose the desired ibaFOB-D card and mark the link, ibaBM-ENetIP is connected to.

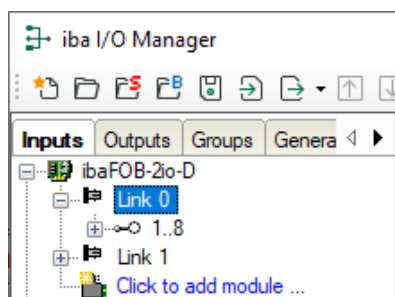

5. Click with the right mouse button on the link and select "Autodetect". The device is identified automatically and shown in the module tree. Depending on the Flex address (switch S2), the device appears at the respective address position 1-15.

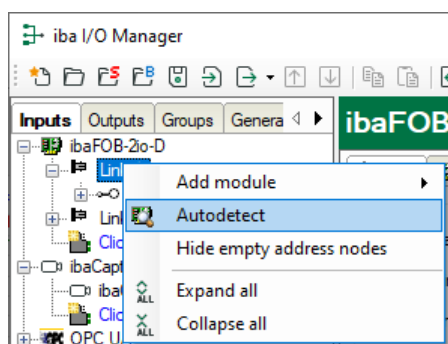

6. Optionally, you can also add the device manually. In this case select "Add module - ibaBM-ENetIP" in the context menu.

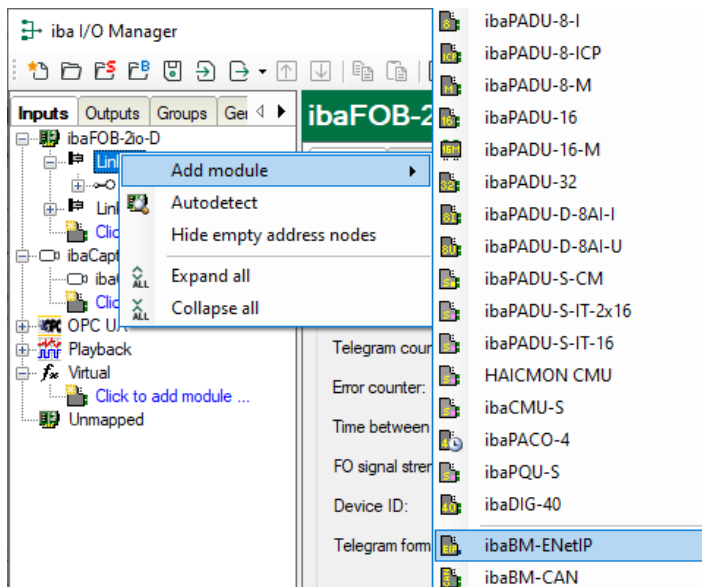

According to the selected Flex address (switch S2), the device has to be dragged to the correct address position using drag & drop.

7. Please define on the "General" tab the parameters of ibaBM-ENetIP. The following parameters are important:
 - Name: Assign a meaningful name to the connected device.
 - Timebase: Select a timebase for data acquisition in ibaPDA.

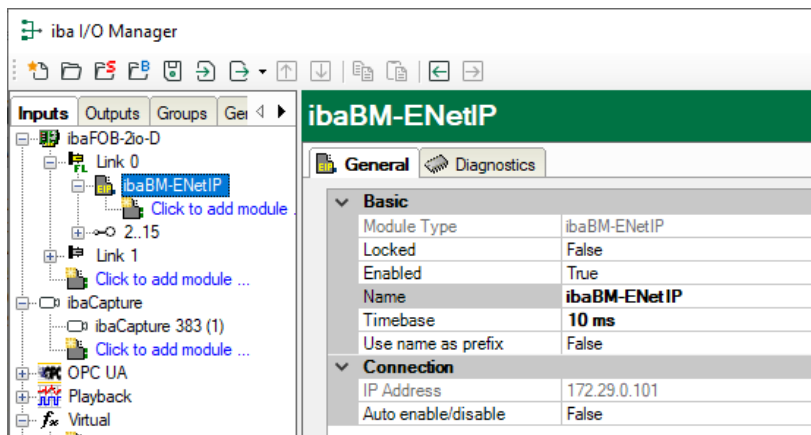

8. Add a module under the ibaBM-ENetIP device. Click with the right mouse-button on the ibaBM-ENetIP device and select "Add module" and the module "EtherNet/IP sniffer" from the list.

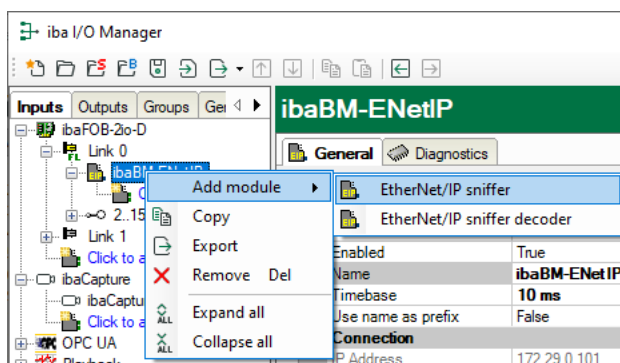

- Now, enter under the module on the “General” tab the source IP address and the destination IP address as well as the “No analog signals” and “No digital signals“. The default setting is 32; a maximum of 1024 analog and 1024 digital signals can be assigned per module. This value determines the length of the signal tables on the “Analog” and “Digital” tabs.

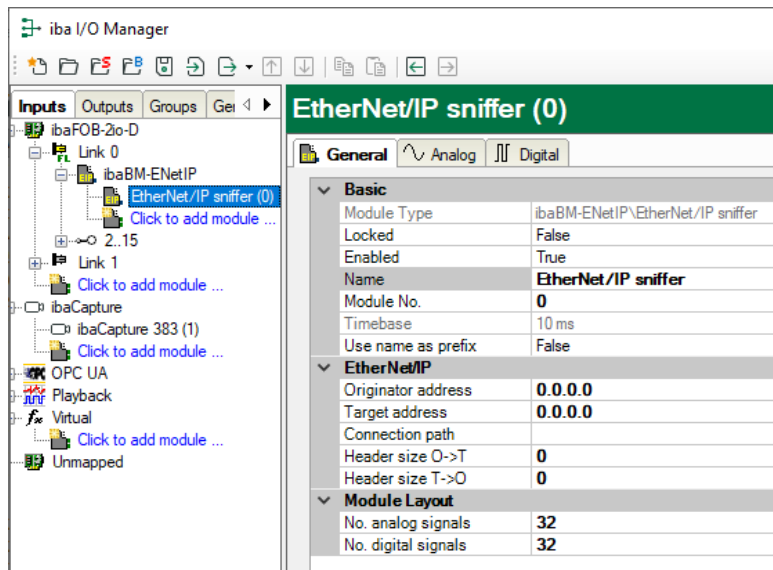

- Enter on the “Analog” tab the signals you want to acquire in sequential order. Assign a name to each signal (“Name“ column) and define in the “Address“ and “Data type“ columns the information about where to find the signal on the interface of the device.

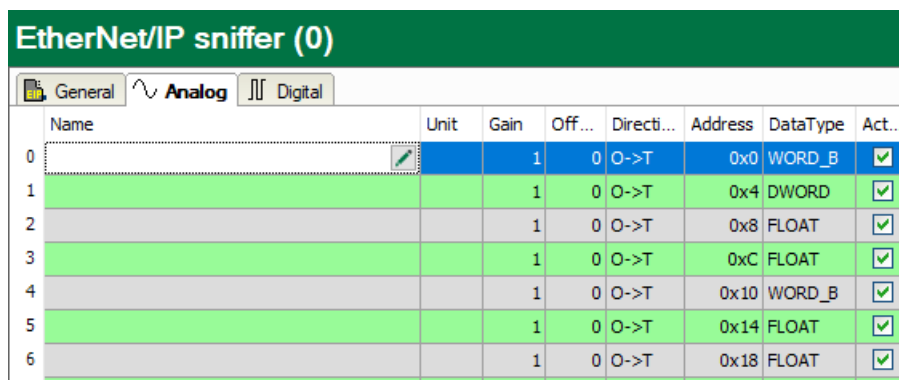



Tip

By clicking on the header of a column, all the settings in the rows below are filled in automatically.

Example:

If you want to configure another data type, beginning with a specific row, then change the data type in the first concerned row. Now, click on the “Data type” header. In all the rows below, the data type is changed automatically.

If you want to have calculated the addresses automatically depending on the selected data type: Configure the correct address in the first row (usually 0) and then click on the “Address” header. Now, considering the selected data types, the addresses are filled in automatically in sequential order. Similar functions are also available for the other columns.

Thus, the project effort can be reduced.

11. If required, select a scaling value of the signals in the “Gain” and “Offset” columns if required, for converting the signals into physical units.
12. For the digital signals on the “Digital” tab, proceed as described above. A data type is not defined. The address offset is given in 1-Byte-steps. The individual signals are addressed via the bit numbers 0 to 7.

EtherNet/IP sniffer (0)

General Analog Digital

Name	Directi...	Add...	Bit no.	Ac...
0	O->T	0x0	0	<input checked="" type="checkbox"/>
1	O->T	0x0	1	<input checked="" type="checkbox"/>
2	O->T	0x0	2	<input checked="" type="checkbox"/>
3	O->T	0x0	3	<input checked="" type="checkbox"/>
4	O->T	0x0	4	<input checked="" type="checkbox"/>
5	O->T	0x0	5	<input checked="" type="checkbox"/>
6	O->T	0x0	6	<input checked="" type="checkbox"/>
7	O->T	0x0	7	<input checked="" type="checkbox"/>
8	O->T	0x1	0	<input checked="" type="checkbox"/>

9.2 Modules in the I/O Manager

If you want to use ibaBM-ENetIP with ibaPDA, you have to configure the device in the ibaPDA I/O Manager. Use the step-by-step procedure described in chapter 9.1.

In the following paragraphs, we describe the available modules.

9.2.1 "ibaBM-ENetIP" device module

The module "ibaBM-ENetIP" contains of 4 different tabs. The "General" and "Diagnostics" tabs are always visible. The "Analog" and the "Digital" tab contain dynamic online views of the analog and digital signals acquired by the device. This is why these two tabs are only visible after modules of „EtherNet/IP sniffer“ type have been added and the configuration has been transferred to the device.

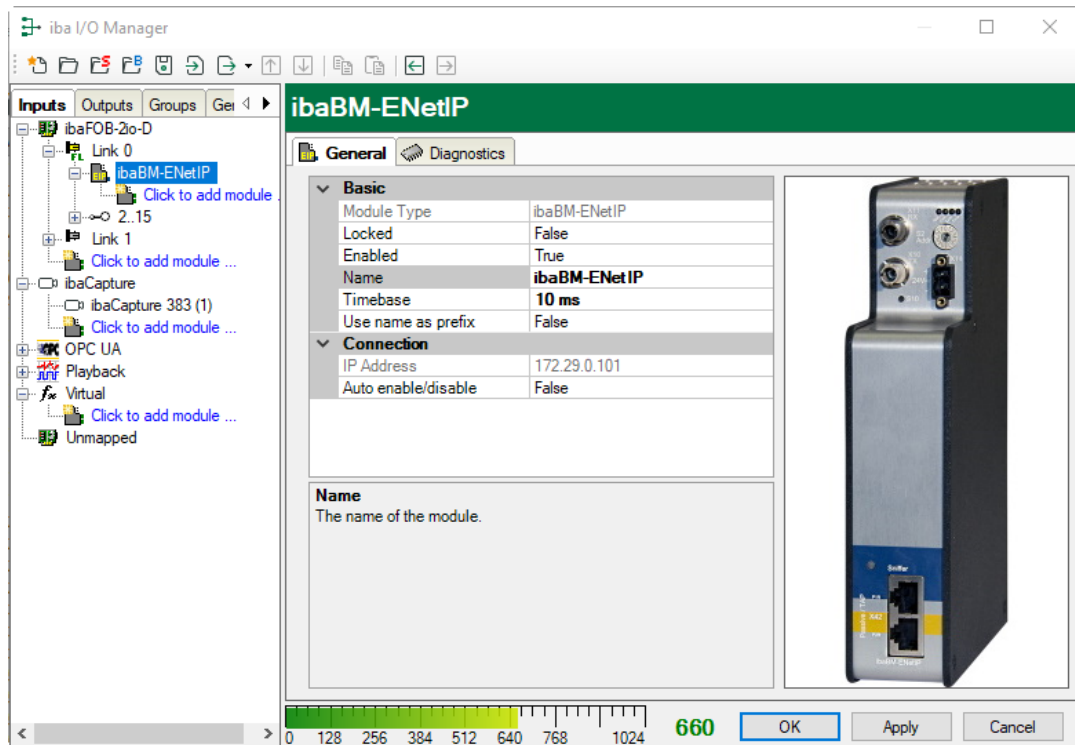

9.2.1.1 "General" tab

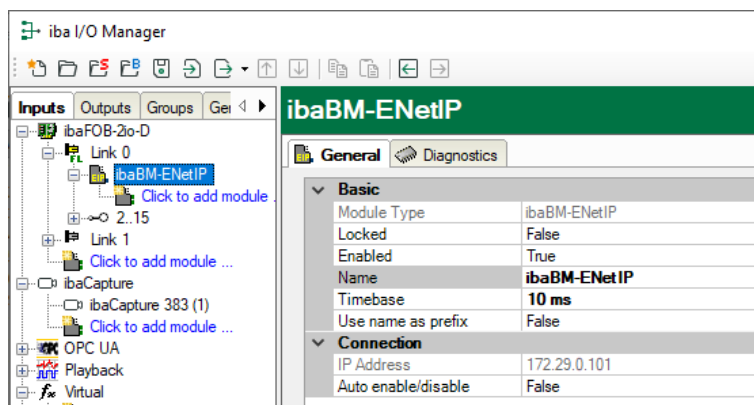

Basic settings

- Module type (read only)
- Display of the module type

Locked

A module can be locked in order to prevent accidental or unauthorized changes in the module settings.

 Enabled

Disabled modules are excluded from signal acquisition.

 Name

Enter here the name for the module as clear text.

 Timebase

Timebase for the data acquisition which is used for this device in ms. Cycles of down to 1 ms are possible (depending on the number of the signals).

 Use name as prefix

The module name is placed in front of the signal name as prefix.

Connection IP address

IP address of the device (via FO); cannot be changed.

 Auto enable/disable

If the value is TRUE, the data acquisition is started even though the device is missing. The missing device is temporarily disabled in the configuration. During the measurement process, ibaPDA tries to re-establish the connection to the missing device. If this is successful, the measurement is restarted automatically including the device that has been missing. If the value is FALSE, the measurement will not be started, in case ibaPDA cannot establish a connection to the device.

9.2.1.2 “Analog“ tab

If analog signals have been configured in the modules „EtherNet/IP sniffer“ and the configuration has been transferred to ibaBM-ENetIP, you will see here an overview of all acquired analog signals with an online overview of the currently acquired values.

ibaBM-ENetIP			
General Analog Digital Diagnostics			
Name	Address	DataType	Actual
Source: (5) EtherNet/IP sniffer			
0	[5:0]	0 WORD_B	0
1	[5:1]	2 DWORD	0
2	[5:2]	6 FLOAT_B	0
3	[5:3]	10 FLOAT_B	0
4	[5:4]	14 WORD_B	0
5	[5:5]	16 WORD_B	0
6	[5:6]	18 FLOAT	0
7	[5:7]	22 FLOAT	0

9.2.1.3 “Digital“ tab

If digital signals have been configured in the modules „Device slot“ and the configuration has been transferred to ibaBM-ENetIP, you will see here an overview of all acquired digital signals with an online overview of the currently acquired values.

ibaBM-ENetIP				
General Analog Digital Diagnostics				
Name	Address	Bit no.	Actual	
Source: (5) EtherNet/IP sniffer				
0	[5.0]	0	0	0
1	[5.1]	0	1	0
2	[5.2]	0	2	0
3	[5.3]	0	3	0
4	[5.4]	0	4	0
5	[5.5]	0	5	0
6	[5.6]	0	6	0
7	[5.7]	0	7	0
8	[5.8]	1	0	0
9	[5.9]	1	1	0

9.2.1.4 “Diagnostics“ tab

On the “Diagnostics“ tab, the current versions of hardware, firmware and FPGA firmware as well as the serial number are displayed. Moreover, you can carry out an update of the firmware and reset the device to the factory defaults.

ibaBM-ENetIP			
General Analog Digital Diagnostics			
<div style="display: flex;"> <div style="flex: 1;"> <p>ibaBM-ENetIP</p> <ul style="list-style-type: none"> 192.168.50.106 <-> 192.168.50.178 <ul style="list-style-type: none"> Assembly.Identity, 100, 101 <ul style="list-style-type: none"> O->T T->O 192.168.50.106 <-> 192.168.50.69 <ul style="list-style-type: none"> Assembly.Message Router, 101, 107 <ul style="list-style-type: none"> O->T T->O 192.168.50.106 <-> 192.168.50.177 <ul style="list-style-type: none"> Assembly.Identity, 100, 101 <ul style="list-style-type: none"> O->T T->O 192.168.50.106 <-> 192.168.50.176 <ul style="list-style-type: none"> Assembly.Identity.Identity.Identity <ul style="list-style-type: none"> O->T T->O </div> <div style="flex: 2;"> <p>General</p> <p>Hardware version: <input type="text" value="A6"/> FPGA version: <input type="text" value="v01.08.0079"/></p> <p>Firmware version: <input type="text" value="v01.02.001-rc8"/> Serial number: <input type="text" value="000022"/></p> <p><input type="button" value="Write firmware"/> <input type="button" value="Reset to factory defaults"/></p> <p>ibaBM-ENetIP</p> <p>Decoder status: EtherNet/IP messages detected. All configured streams detected. (4)</p> <p>Decoder version: <input type="text" value="v01.02.001"/></p> <p>Decoder load: <input type="text" value="1%"/></p> <p>Saved streams: <input type="text" value="4"/></p> <p>Last saved: <input type="text" value="29.04.2020 10:39:46"/></p> <p>Streams: Used: <input type="text" value="8"/> Configured: <input type="text" value="7"/> Max: <input type="text" value="1023"/></p> <p>Monitor port status: Connected, monitor port enabled.</p> </div> </div>			

Firmware update

With the <Write firmware> button, you can install firmware updates. Please select the update file „bmenetip_v[xx.yy.zzz].iba“ in the browser and start the update with <OK>.



Important note

This procedure might take some minutes and must not be interrupted. As soon as the process has been finished, the device restarts automatically.

Reset to factory defaults

Having opened the following dialog by clicking on the button <Reset to factory de-faults>, all settings are reset to factory settings by confirming with <Yes>.

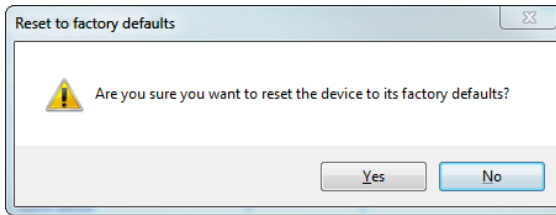

Finally, the following message is shown:

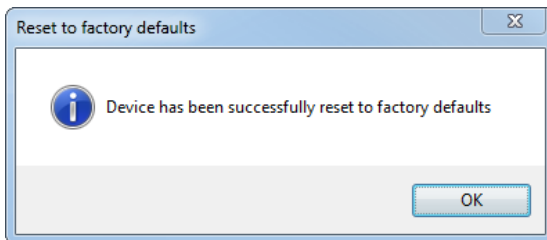

Saved streams, last saved

Number of saved data streams, and the time of the last saving.

Streams used, configured, max.

Number of used, configured and maximum permitted data streams

Monitor port status

Status of the monitor port

Create module

The screenshot displays the 'ibaBM-ENetIP' software interface. On the left, a tree view shows detected connections. One connection is highlighted with a red box: '192.168.50.106 <-> 192.168.50.178'. Below this, several assembly nodes are listed, such as 'Assembly.Identity, 100, 101' and 'Assembly.Message Router, 101, 107'. On the right, a configuration panel for the selected connection is shown. It includes fields for 'Creation time: 20.04.2020 07:56:50', 'Connection serial number: 32772', 'Originator address: 192.168.50.106', 'Originator vendor ID: 1', 'Originator serial number: 1615777331', and 'Target address: 192.168.50.178'. The 'Transport type' is set to 'Direction: Client, Trigger: Cyclic, Class: 1'. The 'Connection path' is shown as '[Key] Assembly Identity Connection Point: 100 Connection Point: 101'. At the bottom, a 'Create module' button is highlighted with a red box.

The connection tree on the left lists all detected EtherNet/IP connections. If you mark a connection and click the button <Create module>, a corresponding "EtherNet/IP sniffer"

module is created. The automatically recognized configuration, such as originator and target address, connection path, header sizes, is adopted.

The button <Create module> is inactive if a module has already been created for this connection.

The parameters on the right side show different EtherNet/IP detailed information.

Display telegram content

The current contents of the respective telegrams are displayed when you mark a branch in the connection tree.

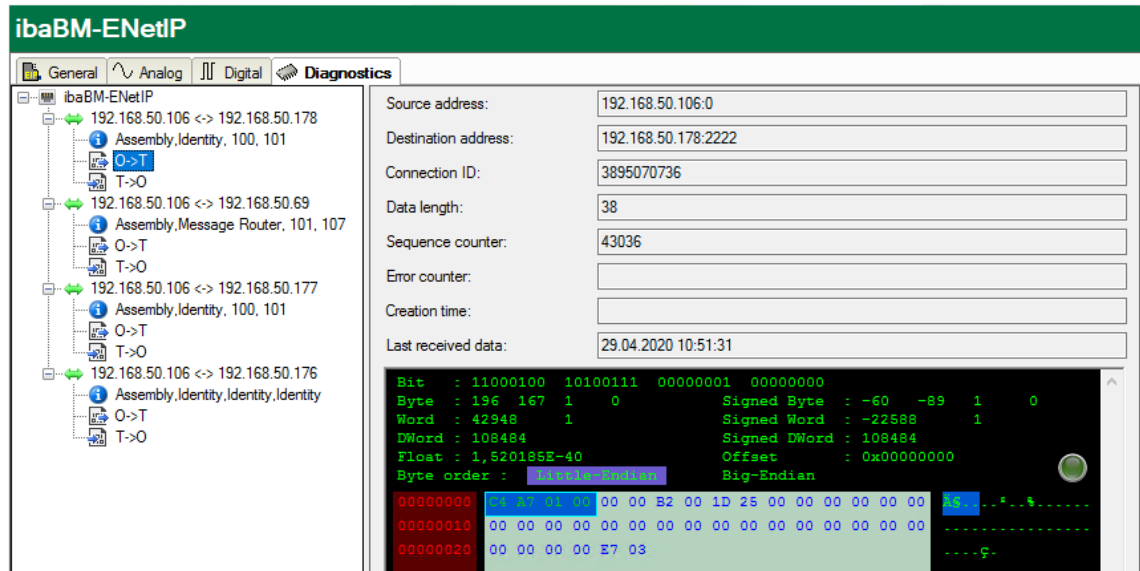

9.2.2 “EtherNet/IP sniffer” module

The module „EtherNet/IP sniffer“ is only available underneath a device node.

9.2.2.1 “General” tab

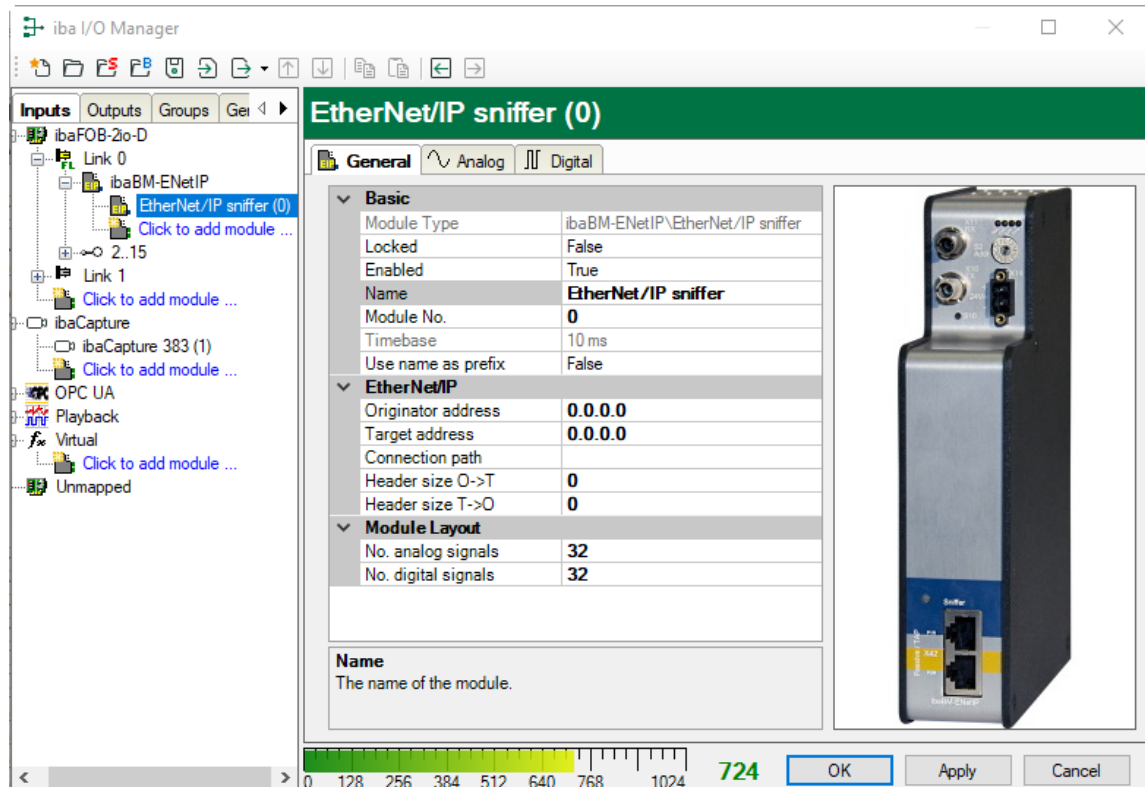

Basic settings

Module type, Locked, Enabled, Name, Timebase, Use name as prefix see chapter 9.2.1.1.

Module No.

Logical module no. for clearly referencing of signals, e.g. in expressions in virtual modules and ibaAnalyzer.

EtherNet/IP

Originator IP address

The IP address of the originator of the EtherNet/IP connection you want to measure. The originator is the one that initiates the connection. This usually is a PLC.

Target IP address

The IP address of the target of the EtherNet/IP connection you want to measure. The target is the one receiving a connection request. This is usually an I/O module.

Connection path

The connection path of the EtherNet/IP connection you want to measure. This uniquely identifies a connection between an originator and a target. If there is only a single connection between the originator and the target then the connection path is not required.

Header size O->T

The size of the CIP real time format header. This determines the position of signal address 0 in the EtherNet/IP user data.

Header size T->O

The size of the CIP real time format header. This determines the position of signal address 0 in the EtherNet/IP user data.

Module Layout

No. analog signals

Defining the number of analog signals for this module (max. 1024).

No. digital signals

Defining the number of analog signals for this module (max. 1024).

9.2.2.2 “Analog“ tab

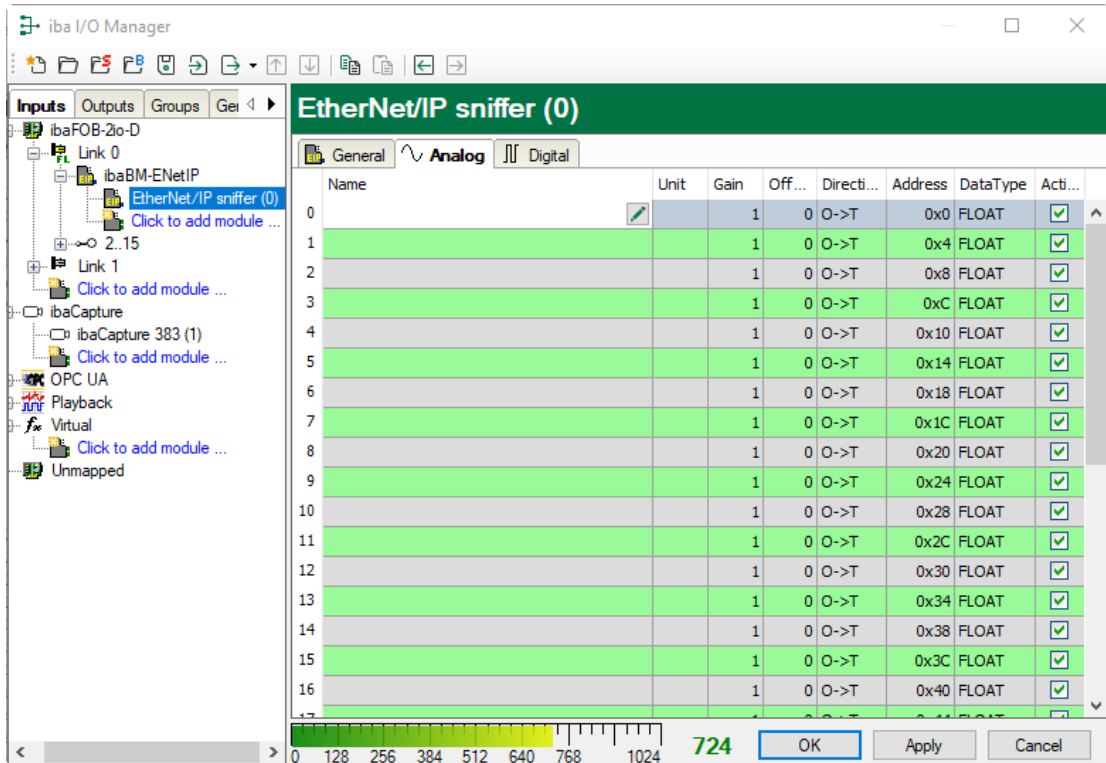

Enter the analog signals you want to acquire in sequential order here. The individual columns in the signal list have the following meanings:

Name

Here, you can enter a signal name and additionally two comments, if you click on the  icon on the signal name field.

Unit

Here, you can enter the physical unit of the analog value.

Gain / Offset

Gradient (Gain) and y axis intercept (Offset) of a linear equation. You can convert a standardized and no unit value transferred into a physical value.



Example

For a AI/AO module that provides a value range of -32767 up to 32768 which represents a physical value of e.g. 50°C up to 500°C you can choose by Gain / Offset a correct conversion of the value. The no unit value is then recorded with the physical unit.

For making the calculation of Gain/Offset easier, an auxiliary dialog appears when clicking on the co-ordinate cross icon in the "Gain" or "Offset" field. In this dialog, you only enter two points in the line equation. Gain and offset are then calculated automatically.

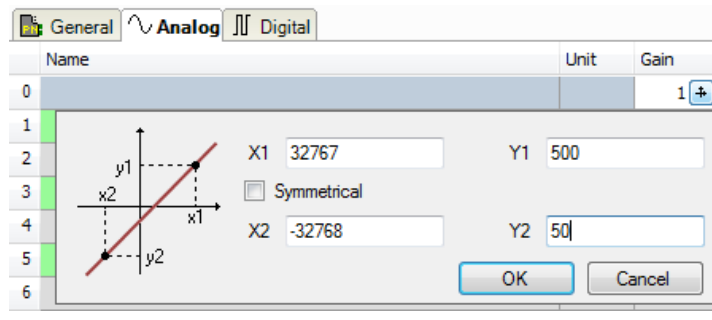

Direction

Select the direction from the drop-down menu:

O->T: originator -> target

T->O: target -> originator

Address

The Byte address of the signal within the input and output range of the device. The address range always begins with the address 0.



Tip

When entering the signals of a device in sequential order, only the data types have to be selected for all signals. The Byte addresses of the signals are then calculated automatically. For this purpose, please enter only for the first signal of the desired device the correct Byte address into the address column and then click on the column header. Starting with the first address (where the cursor is positioned) and considering all data types, the addresses of the other signals of this device are filled in automatically.

Active

When this option is selected, the signal is acquired and also considered when checking the number of licensed signals.

More columns can be displayed or hidden, using the context menu (right mouse-click on the header).

9.2.2.3 “Digital“ tab

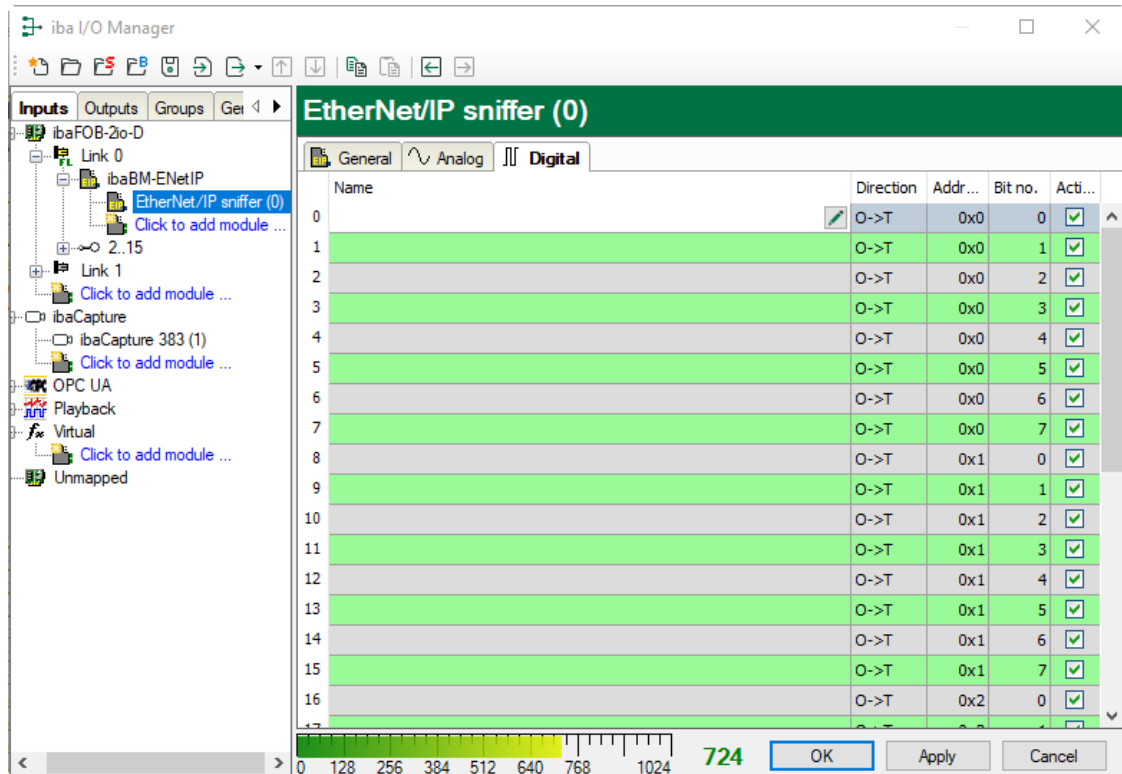

Enter here the digital signals you want to record in sequential order. The columns in the signal list have the following meaning:

Name

Here, you can enter a signal name and additionally two comments, if you click on the  icon on the signal name field.

Direction

Select the direction from the drop-down menu:

O->T: originator -> target

T->O: target -> originator

Address

The Byte address of the signal within the input and output range of the device. The address range always begins with the address 0.

Bit No.

Enter the Bit no within the Byte defined as “Address“.

Active

When this option is selected, the signal is acquired and is also considered when checking the number of licensed signals.

More columns can be displayed or hidden, using the context menu (right mouse-click on the header).

9.2.3 “EtherNet/IP sniffer decoder” module

The module „EtherNet/IP sniffer“ is only available below an "ibaBM-ENetIP" node.

The "Sniffer decoder" module is suitable for acquiring large amounts of digital signals that are present in the form of bytes, words, or double words in an EtherNet/IP network.

9.2.3.1 “General” tab

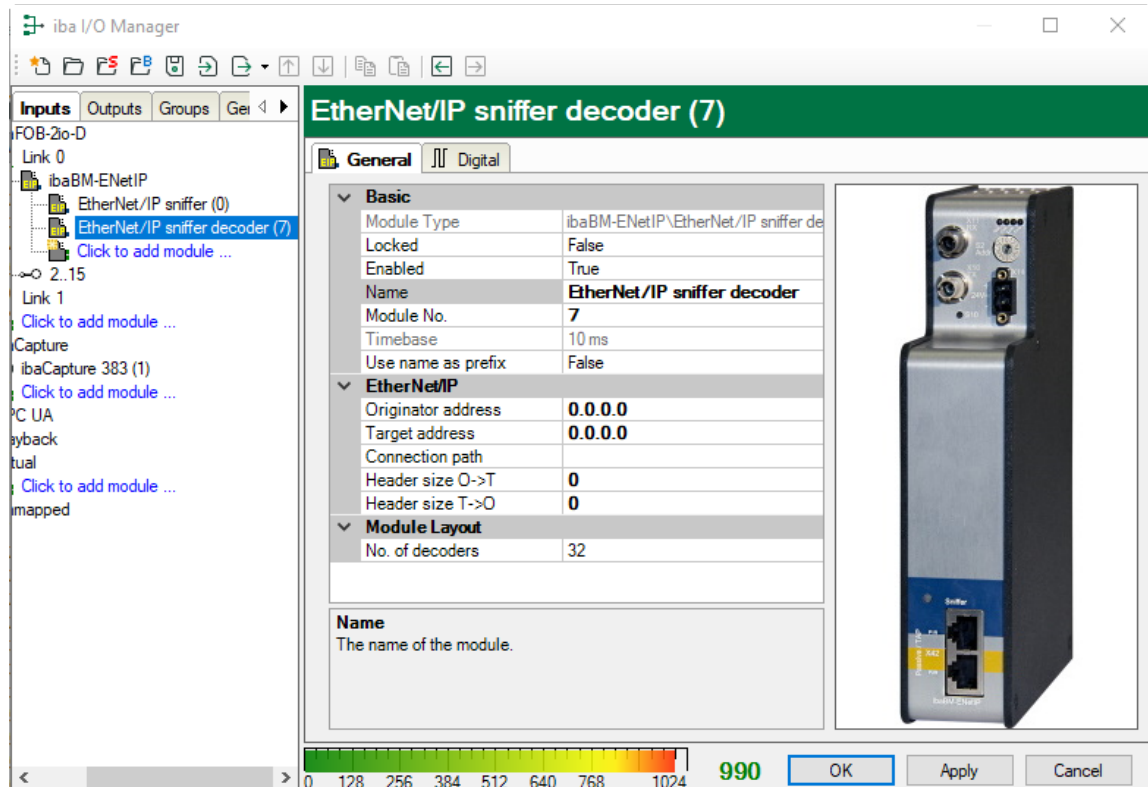

Basic

Locked, Enabled, Timebase, Use name as prefix
See chapter 9.2.1.1

Module No.

Internal reference number of the module. This number determines the order of the modules in the signal tree of ibaPDA client and ibaAnalyzer.

EtherNet/IP

Originator address, Target address, Connection path, Header size O->T, Header size T->O

See chapter 9.2.2.1

Module Layout

No. of decoders

Specify the number of analog values that can be decoded into digital signals (max. 256).

9.2.3.2 “Digital” tab

The signals are declared in two steps. First, the signals you want to acquire as source for the digital signals have to be defined in sequential order.

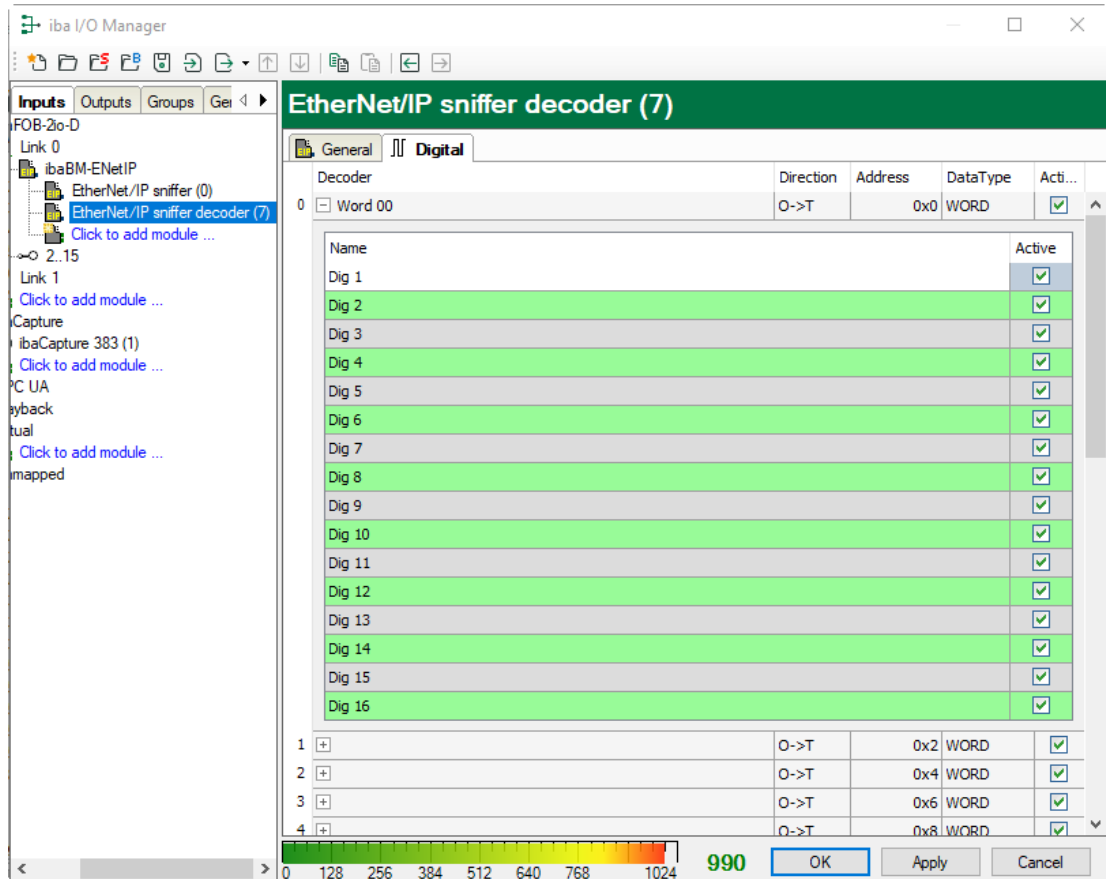

Enter here the signals, which contain the digital signals in sequential order. The columns in the signal list have the following meaning:

Decoder

Assign a meaningful name to the source signal.

Direction

Select the direction from the drop-down menu:

O->T: originator -> target

T->O: target -> originator

Address

The Byte address of the signal within the input and output range of the device. The address range always begins with the address 0.

Data Type

Data type of the signal. The following are available: BYTE, WORD, WORD_B, DWORD, DWORD_B.

Active

With this option enabled, the source signal is acquired with its digital signals and is also considered when checking the number of licensed signals. Individual digital signals can be disabled.

For every source signal, the list of digital signals can be opened by clicking on the plus sign. Here, the single bits of the source signal are defined.

Name

Assign a meaningful name to the individual signals.

 Active

Only when this option is selected, the signal is acquired and considered when checking the number of licensed signals.

**Note**

Only the activated digital signals are considered when counting the number of licensed signals, hence no additional signal for the source signal.

ibaBM-ENetIP only acquires one analog value, which is then decoded by ibaPDA.

Thus, the range of analog values is used in ibaBM-ENetIP for acquiring large amounts of digital signals.

9.3 Calculation of the telegram size with 32Mbit Flex

The data size per participant is dynamically allocated in a 32Mbit Flex ring. The data size is calculated by ibaPDA and it depends on the configured number of analog and digital signals and the smallest configured timebase in the ring.

In ibaPDA, in the link view of the ibaFOB-D card on the “Configuration“ tab, you can access a simulator. This simulator calculates the data amount which can be transferred via the FO connection with the 32Mbit Flex protocol.

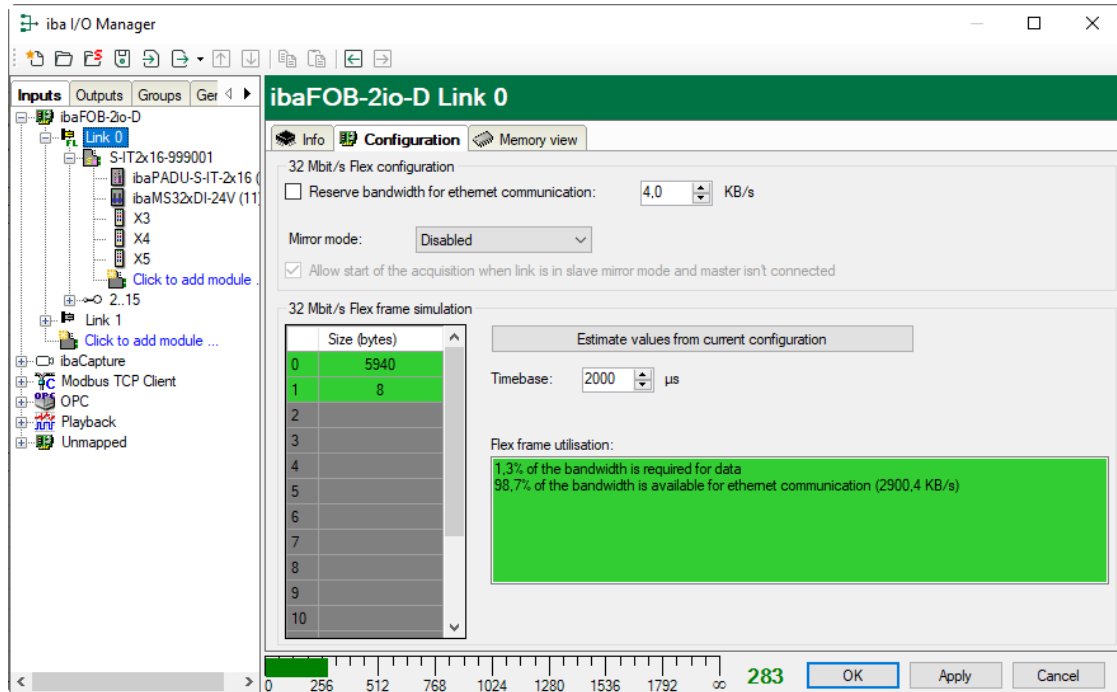

The data sizes in bytes of each device on the link and the timebase of the data acquisition on the link (in μs) is needed for the calculation.

The values can be manually entered or taken automatically from the current configuration, either with a click on the button <Estimate values from current configuration> or when the respective link of the ibaFOB card is marked in the module tree.

The devices in the Flex ring and the corresponding data sizes are listed in the grid on the left. Address 0 corresponds to the Ethernet channel and is not editable.

The section “Flex frame utilization” indicates how much of the bandwidth is still available. The color of the section changes with the utilization rate:

- Green: OK
- Orange: bandwidth for the Ethernet channel < 3 kB/s
- Red: too much data.

The automatically derived values are a first estimation: The firmware of the individual devices determines where in the Flex telegram the data are transferred. Filling bytes can be inserted between the requested data. After the configuration has been applied with a click on <OK> or <Apply>, the actual data values are displayed on the “Info“ tab.

Reserved bandwidth for Ethernet communication

The Ethernet channel (address 0) is used to transmit configuration data. If many devices are configured with a lot of signals, it may happen, that only the minimum size of 1 kB/s is reserved for Ethernet communication. This is not sufficient in many cases and may cause, that the configuration data are transmitted only slowly or cannot be transmitted at all.

It is now possible to reserve a fixed bandwidth for the Ethernet channel with the option "Reserve bandwidth for ethernet communication".

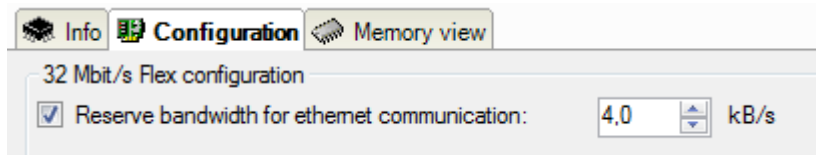

10 EtherNet/IP engineering

CAUTION

Connecting and removing network cables

Changes in the EtherNet/IP network might have an impact on the functionality of the control system.

10.1 Operation as sniffer

When the device operates as sniffer, no configuration in the engineering tool of the used EtherNet/IP scanners (master) is necessary.

To configure ibaPDA, knowledge concerning the structure of the transferred user data is needed, basically the following information:

- Between which scanner and which adapter the data is transferred
- Will the data be transferred from the scanner to the adapter (OUTPUT) or will it be transferred from the adapter to the scanner (INPUT)
- Where (Byte offset) in the slot data the corresponding signal is saved and which data type is used.

A distinction must be made between (TCP) connections and (UDP) data streams. An EtherNet/IP connection usually consists of one connection and two data streams (one in each direction). The data streams are used for cyclic IO data exchange.

The following technical restrictions are to be taken into consideration:

- To detect the EtherNet/IP connection, the telegram traffic must be sniffed during connection setup (CPU start-up, cable reconnection). If this is not the case, only the running data streams are detected. In this case, it may be that the cyclic I/O data cannot always be clearly assigned to EtherNet/IP connections. Data acquisition is then not reasonably possible.
- A maximum of 1024 analog and 1024 digital signals from up to 64 bidirectional connections can be configured.
- Up to 1023 data streams and 511 connections can be displayed in the online diagnostics.

11 Technical data

11.1 Main data

Manufacturer	iba AG, Germany	
Order no.	13.120010	
Description	EtherNet/IP bus monitor	
EtherNet/IP interface		
TAP interface (sniffer)	2-port TAP, 2 x RJ45 socket, 10/100 Mbit/s	
ibaNet interface		
Number	1 (e. g. for the connection to ibaPDA)	
ibaNet protocol	32Mbit Flex (bidirectional) Up to 15 devices can be connected in a FO ring topology Can be used for data, settings and service purposes (e.g. updates) max. 1024 analog signals (BYTE, INT, WORD, DINT, DWORD, FLOAT, Big/Little Endian) + max. 1024 digital signals (BOOL) max. 4060 Bytes at a cycle time of 1.4 ms	
Data transmission rate	32 Mbit/s	
Sampling time	From 1 ms, freely adjustable	
Connection technology	2 ST connectors for RX and TX; iba recommends the use of FO with multimode fibers of type 50/125 µm or 62.5/125 µm; For information on cable length, see chap. 11.3	
Transmitting interface (TX)		
Output power	50/125 µm FO cable	-19.8 dBm to -12.8 dBm
	62.5/125 µm FO cable	-16 dBm to -9 dBm
	100/140 µm FO cable	-12.5 dBm to -5.5 dBm
	200 µm FO cable	-8.5 dBm to -1.5 dBm
Temperature range	-40 °F to 185 °F (-40 °C to 85 °C)	
Light wavelength	850 nm	
Receiving interface (RX)		
Sensitivity ²	62.5/125 µm FO cable	-30 dBm
Temperature	77 °F (25 °C)	
Further interfaces, operating and indicating elements		
Power supply	24 V DC ±10% not stabilized 2-pin connector, clamp-type terminal (0.2 mm ² to 2.5 mm ²), screw connection, included in delivery	
Power consumption	Up to 9.6 W	
Rotary switch	Device address (in the cascade)	

² Data for other FO cable diameters not specified

Indicators	4 LEDs for device status Multi-color LED TAP interface
Monitor interface	Ethernet RJ45 1 Gbit/s
Service interface	Ethernet RJ45 10/100/1000 Mbit/s
Grounding screw	
Operating and environmental conditions	
Cooling	Passive
Operating temperature range	32 °F to 122 °F (0 °C to 50 °C)
Storage temperature range	-13 °F to 158 °F (-25 °C to 70 °C)
Transport temperature range	-13 °F to 158 °F (-25 °C to 70 °C)
Humidity class (DIN 40040)	F, no condensation
Protection class	IP20
Mounting	DIN rail, vertical
Norms and standards	EMC: IEC 61326-1 FCC part 15 class A
Dimensions (width x height x depth)	1.61 in x 7.87 in x 5.51 in (41 mm x 200 mm x 140 mm), incl. DIN rail clip
Weight (incl. packaging and manual)	approx. 1.0 kg

11.2 Dimensions

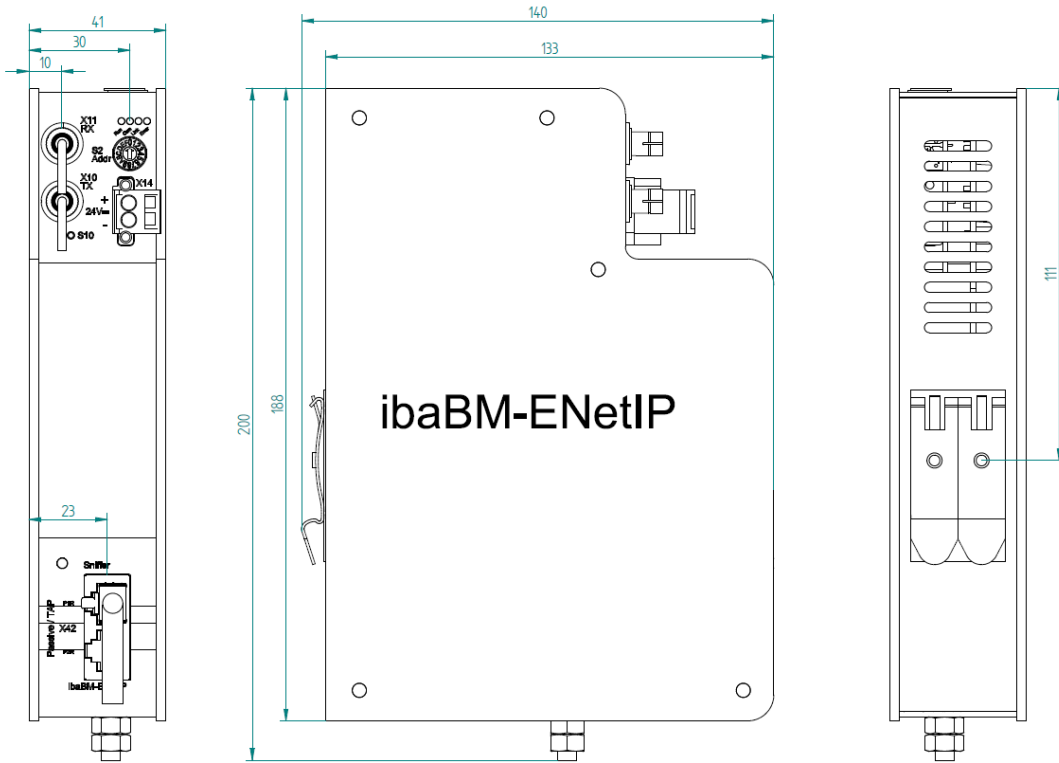

(Dimensions in mm)

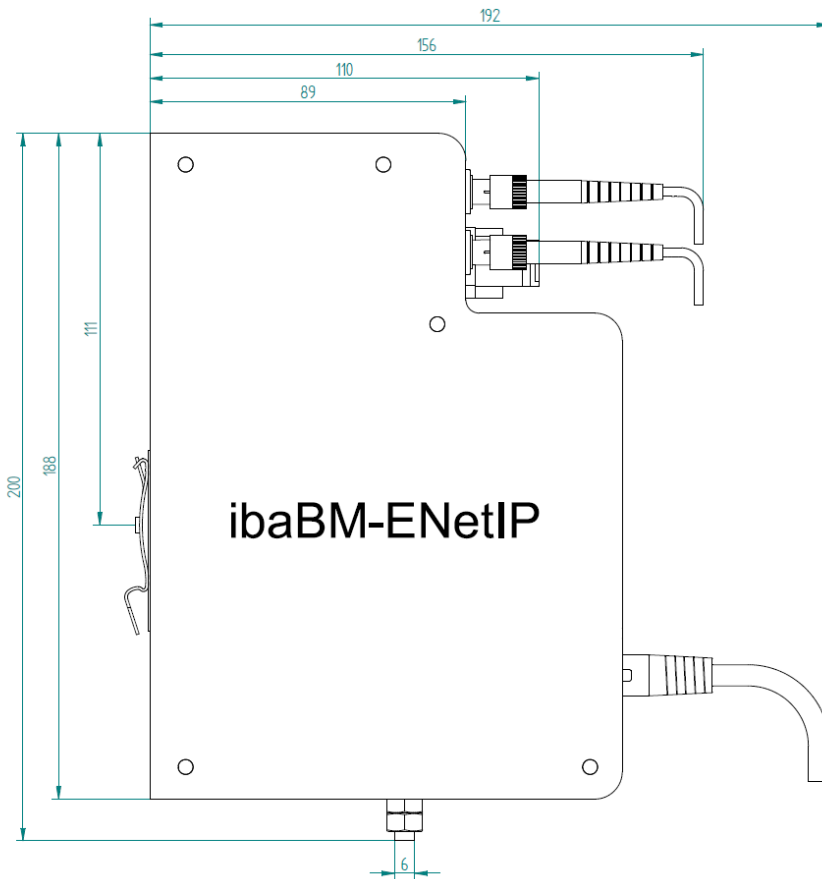

(Dimensions in mm)

11.3 Example for FO budget calculation

As an example, an FO connection from an ibaFOB-io-Dexp card (FO transmitter) to an ibaBM-PN device (FO receiver) is used.

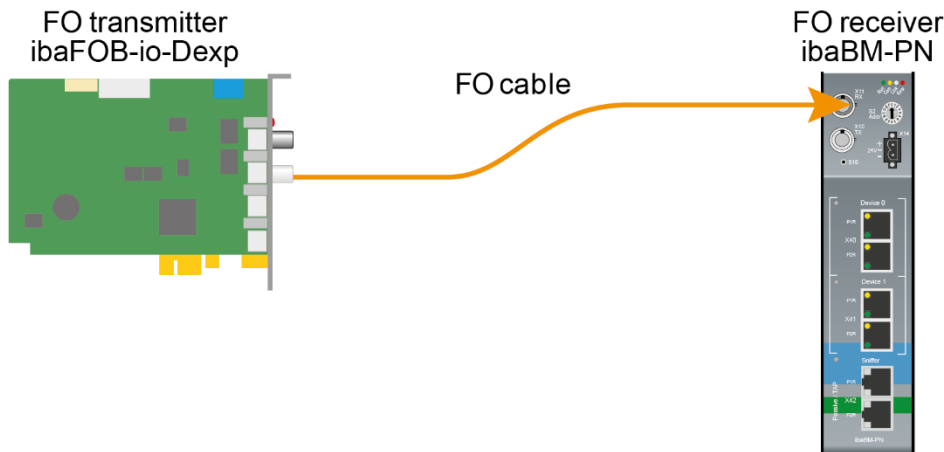

The example refers to a point-to-point connection with an FO cable of type 62.5/125 μm . The light wavelength used is 850 nm.

The range of the minimum and maximum values of the output power or receiver sensitivity depends on the component and, among other things, on temperature and aging.

For the calculation, the specified output power of the transmitting device and on the other side the specified sensitivity of the receiving device must be used in each case. You will find the corresponding values in the respective device manual in the chapter "Technical data" under "ibaNet interface".

Specification ibaFOB-io-Dexp:

Output power of FO transmitting interface		
FO cable in μm	Min.	Max.
62.5/125	-16 dBm	-9 dBm

Specification ibaBM-PN:

Sensitivity of FO receiving interface		
FO cable in μm	Min.	Max.
62.5/125	-30 dBm	

Specification FO cable

To be found in the data sheet of the fiber optic cable used:

FO cable	62.5/125 μm
Connector loss	0.5 dB connector
Cable attenuation at 850 nm wavelength	3.5 dB / km

Equation for calculating the FO budget (A_{Budget}):

$$A_{Budget} = |(P_{Receiver} - P_{Sender})|$$

$P_{Receiver}$ = sensitivity of FO receiving interface

P_{Sender} = output power of FO transmitting interface

Equation for calculating the fiber optic cable length (l_{Max}):

$$l_{Max} = \frac{A_{Budget} - (2 \cdot A_{Connector})}{A_{Fiberoptic}}$$

$A_{Connector}$ = connector loss

$A_{Fiberoptic}$ = cable attenuation

Calculation for the example ibaFOB-io-Dexp -> ibaBM-PN in the best case:

$$A_{Budget} = |(-30 \text{ dBm} - (-9 \text{ dBm}))| = 21 \text{ dB}$$

$$l_{Max} = \frac{21 \text{ dB} - (2 \cdot 0.5 \text{ dB})}{3.5 \frac{\text{dB}}{\text{km}}} = 5.71 \text{ km}$$

Calculation for the example ibaFOB-io-Dexp -> ibaBM-PN in the worst case:

$$A_{Budget} = |-30 \text{ dBm} - (-16 \text{ dBm})| = 14 \text{ dB}$$

$$l_{Max} = \frac{14 \text{ dB} - (2 \cdot 0.5 \text{ dB})}{3.5 \frac{\text{dB}}{\text{km}}} = 3.71 \text{ km}$$

**Note**

When connecting several devices as daisy chain (e.g. ibaPADU-8x with 3Mbit) or as ring (e.g. ibaPADU-S-CM with 32Mbit Flex), the maximum distance applies to the section between two devices. The FO signals are re-amplified in each device.

**Note**

When using fiber optics of the 50/125 μm type, a distance reduction of approx. 30-40% must be expected.

12 Support and contact

Support

Phone: +49 911 97282-14

Fax: +49 911 97282-33

E-Mail: support@iba-ag.com



Note

If you require support, specify the serial number (iba-S/N) of the product.

Contact

Headquarters

iba AG

Koenigswarterstrasse 44

D-90762 Fuerth

Germany

Phone.: +49 911 97282-0

Fax: +49 911 97282-33

E-mail: iba@iba-ag.com

Mailing address

iba AG

Postbox 1828

D-90708 Fuerth

Germany

Delivery address

iba AG

Gebhardtstrasse 10

DE-90762 Fuerth

Germany

Regional and Worldwide

For contact data of your regional iba office or representative please refer to our web site

www.iba-ag.com.