

ibaPADU-8-ICP

Parallel A/D Converter Unit for Fast Measurement with ICP Sensors



Manual

Issue 1.7

Measurement and Automation Systems



Manufacturer

iba AG
Koenigswarterstr. 44
90762 Fuerth
Germany

Contacts

Main office	+49 911 97282-0
Fax	+49 911 97282-33
Support	+49 911 97282-14
Engineering	+49 911 97282-13

E-Mail: iba@iba-ag.com

Web: www.iba-ag.com

This manual must not be circulated or copied, or its contents utilized and disseminated, without our express written permission. Any breach or infringement of this provision will result in liability for damages.

©iba AG 2012, All Rights Reserved

The content of this publication has been checked for compliance with the described hardware and software. Nevertheless, deviations cannot be excluded completely so that the full compliance is not guaranteed. However, the information in this publication is updated regularly. Required corrections are contained in the following regulations or can be downloaded on the Internet.

The current version is available for download on our web site <http://www.iba-ag.com>.

Protection note

Windows® is a label and registered trademark of the Microsoft Corporation. Other product and company names mentioned in this manual can be labels or registered trademarks of the corresponding owners.

Certification

The device is certified according to the European standards and directives. This device corresponds to the general safety and health requirements. Further international customary standards and directives have been observed.



Version	Date	Revision	Chapter / pages	Author	Appr.	Version HW/FW
V1.7	04/19/12	Configuring in ibaPDA	10.2.	st		

Table of contents

1	About this manual.....	5
1.1	Target group.....	5
1.2	Notations.....	5
1.3	Used symbols.....	6
2	Introduction.....	7
3	Scope of delivery.....	8
4	Safety instructions.....	8
4.1	Designated use.....	8
4.2	Special advices.....	8
5	System requirements.....	9
5.1	Hardware.....	9
5.2	Software.....	9
6	Mounting and dismounting.....	10
6.1	Mounting.....	10
6.2	Dismounting.....	10
7	Device description.....	11
7.1	Properties.....	11
7.2	Device view.....	12
7.2.1	Power Supply Connection.....	13
7.2.2	Fiber-optic Ports RX and TX.....	13
7.2.3	Setting the Device Address with S1 and S2 Decade Switches.....	13
7.2.4	Terminal Blocks Pin Connections X1, X5, X14.....	13
7.2.5	Run, Link and Error LED Indicators.....	14
7.2.6	Binary LED Indicators.....	14
7.2.7	Service Interface.....	15
7.2.8	Shield Connector for Physical Earth.....	15
8	System integration.....	16
8.1	Process Monitoring Topology Example.....	17
8.2	Online Machine Condition Monitoring Topology.....	18
9	Programmable Settings of the Device.....	19
9.1	Sampling Rate.....	19
9.2	Input Gain.....	19
9.3	Low-Pass Filter.....	20
10	Configuration.....	22
10.1	Working with ibaLogic-V3.....	22
10.1.1	Typical Configuration.....	22

10.1.2	Hardware Settings	23
10.1.3	Checking the Communication with the Help of ibaDiag	25
10.1.4	Input Resources iba FOB-M/IN	27
10.1.5	Output Resources for iba FOB-M (FOB-M/Out).....	28
10.1.6	Control of ibaPADU-8-ICP in ibaLogic application program.....	29
10.1.7	Data Buffer Size	30
10.2	Configuring with ibaPDA	30
10.2.1	Configuring ibaPADU-8-ICP:.....	30
10.2.2	Configuring Triggers.....	35
10.2.3	Configuring the Data Store.....	38
10.2.4	Configuring the Signal View	39
11	Technical data	40
12	Support and contact.....	41

1 About this manual

This manual describes the construction, the use and the operation of the device ibaPADU-8-ICP.

For further information concerning the system integration and software configuration please refer to the corresponding engineering manuals and / or software documentation of our software products used in conjunction with this device.

1.1 Target group

This manual addresses in particular the qualified professionals who are familiar with handling electrical and electronic modules as well as communication and measurement technology. A person is regarded to as professional if he/she is capable of assessing safety and recognizing possible consequences and risks on the basis of his/her specialist training, knowledge and experience and knowledge of the standard regulations.

1.2 Notations

The following designations are used in this manual:

Action	Notations
Menu command	Menu „Logic diagram“
Call of menu command	„Step 1 – Step 2 – Step 3 – Step x“ Example: Select menu „Logic diagram – Add – New logic diagram“
Keys	<Key name> Example: <Alt>; <F1>
Press keys simultaneously	<Key name> + <Key name> Example: <Alt> + <Ctrl>
Buttons	<Button name> Example: <OK>; <Cancel>
File names, Paths	„File name“, „Path“ Example: „Test.doc“

1.3 Used symbols

If safety instructions or other notes are used in this manual, they mean:

DANGER

The non-observance of this safety information may result in an imminent risk of death or severe injury:

- By an electric shock!
 - Due to the improper handling of software products which are coupled to input and output procedures with control function!
-

WARNING

The non-observance of this safety information may result in a potential risk of death or severe injury!

CAUTION

The non-observance of this safety information may result in a potential risk of injury or material damage!



Note

A note specifies special requirements or actions to be observed.



Important note

Note if some special features must be observed, for example exceptions from the rule.



Tip

Tip or example as a helpful note or insider tip to make the work a little bit easier.



Other documentation

Reference to additional documentation or further reading.

2 Introduction

The ibaPADU-8-ICP (parallel analog & digital unit 8 channel ICP) serves as a data acquisition device for applications requiring sample rates to 25 kHz per channel. This device is suitable for vibration measurement applications, such as ...

- machine vibration monitoring
- rolling element bearing monitoring
- rolling mill chatter monitoring
- various dynamic process monitoring

Since the majority of applications require measurements from ibaPADU-8-ICP devices on a scheduled, periodic basis, devices are multiplexed. Each of up to 4 fiber-optic links (on a iba FOB 4i PCI-card) may interface with individually addressed ibaPADU-8-ICP units. Depending on the processing power of the PC, either 8, 16, 24 or 32 ICP and binary channels may be sampled simultaneously.

Per fiber-optic link, a maximum of 96 devices can be addressed via a ibaFOB-4i/-4o combination or a ibaFOB-io card interface. This provides a maximum of $4 \times 96 \times 8 = 3072$ analog and digital measurement channels. Each analog channel can be connected directly to ICP[®] type sensors without interposing signal conditioning. ICP[®] sensors must meet the specification of IMI¹, whereby each channel is powered with a current loop. This provides both a signal level for measurement as well as open-circuit, short-circuit detection possibility.

Another possible application is the simultaneous monitoring of up to 128 analog and 128 binary channels with up to 25 ks/s. This operational mode is supported by PCI cards in combination with the iba Online Data Acquisition software ibaScope only! The master ibaFOB in that case controls the ADC converter triggering with an accuracy of max 100 ns (plus fiber optic cable length = approx. 4 ns /m) difference without any jittering. This allows a variety of new applications to be performed in a wide area with a big amount of simultaneous signals.

In order to provide a rich dynamic range, each ICP[®] channel comprises a programmable analog gain, programmable low-pass filter, and a 14-bit ADC.

¹ IMI is a division of PCB Piezotronics, Depew, NY

3 Scope of delivery

After unpacking check the completeness and intactness of the delivery.

The scope of delivery includes:

- ibaPADU-8-ICP Device with Phoenix terminal blocks
- ibaPADU-8-ICP Documentation
- 2 each Phoenix terminal blocks for the ICP[®] channels
- 1 each Phoenix terminal block for the binary channels

4 Safety instructions

4.1 Designated use

The device is electrical equipment. It may be used only in the following applications:

- Measurement data logging and analysis
- Applications of ibaSoftware products (ibaLogic, ibaPDA-V6 etc.)

The device may not be operated in mains supply circuits!

4.2 Special advices



Important note

Do not open the device!

There are no serviceable parts inside the device.

Opening the device will void the warranty.



Note

Sensor cable shield should be connected only on the ibaPADU-8-ICP side in order to avoid ground loops with the sensor housing.



Note

Always ground the DIN rail on which the device is installed.



Note

Cleaning

To clean the device, use a dry or slightly moistened cloth. A note specifies special requirements or actions to be observed.

5 System requirements

5.1 Hardware

- ❑ Compatible PC with
 - 500 MHz Dual Pentium III CPU or higher
 - Minimum 1 free slot for ibaFOB card
 - 128 MB RAM
 - at least 19 GB hard disk storage capacity
- ❑ Interface hardware (one of the following cards):
 - ibaFOB-io-S or
 - ibaFOB-4i-S + ibaFOB-4o
 - ibaFOB-io-D or ibaFOB-io-Dexp
 - ibaFOB-2io-D or ibaFOB-2io-Dexp
 - ibaFOB-4i-D or ibaFOB-4i-Dexp and ibaFOB-4o.
 - ibaFOB-io-ExpressCard (for notebook)

5.2 Software

- ❑ Online measurement/monitoring software
 - ibaScope V 3.0.01 or higher
 - ibaLogic Version 3.60 or higher
 - ibaPDA Version 6.15.0 or higher
 - ibaChatter (available from iba America, LLC, www.iba-ag.com)
- ❑ Analysis software
 - ibaAnalyzer Version 2.5 and higher

6 Mounting and dismounting

6.1 Mounting

1. Place the mounting rail clip attached to the device on the mounting rail.
2. Press the device down in such a way that the clip of the mounting rail engages with a click.
3. Connect the 24 V DC power supply to the termination shown on the device. Ensure that the polarity is correct prior to applying power.
4. Connect fiber-optic cable to the TX/RX ports as shown on the device so that the fiber-optic ring is completed

6.2 Dismounting

1. Disconnect the power supply.
2. Disconnect all cables.
3. Close the open fiber optic inputs and outputs with a cover.
4. Hold the device to prevent it from falling down and press it slightly downwards.
5. After that pull the device and lift it up. The clip of the mounting rail will disengage with a click.
6. Remove the device.
7. When storing or transporting the device observe the values specified in the technical data.

7 Device description

7.1 Properties

The ibaPADU-8-ICP has the following properties.

- 24 V DC unregulated external power supply required (18..32V input voltage possible).
- DIN rail mountable, EMI protected, robust metal housing
- 3 LED device status indicators (Run/Link/Error)
- TX/RX fiber-optic ports for transmission of measured data and reception of configuration requests as well as multiplexing of up to 96 devices
- Programmable sampling frequency (period)
 - minimum 500 Hz (2 msec)
 - maximum 25 kHz (40 μ s)
 - sampling period increment of 50 nanoseconds
- 8 analog inputs with
 - ICP® sensor power
 - 14-bit ADC
 - programmable gain (0 dB...60 dB)
 - programmable low-pass filter
 - galvanic isolation
- 8 binary inputs with
 - galvanic isolation
 - 8 status outputs via LED
- Maximum device communication speed of 200 k samples per second (25 kHz per channel)
- RJ11 socket (iba PCMCIA interface card is not yet supported)
- Service interface
- Shield terminal for proper grounding of the device to eliminate ground loops

7.2 Device view

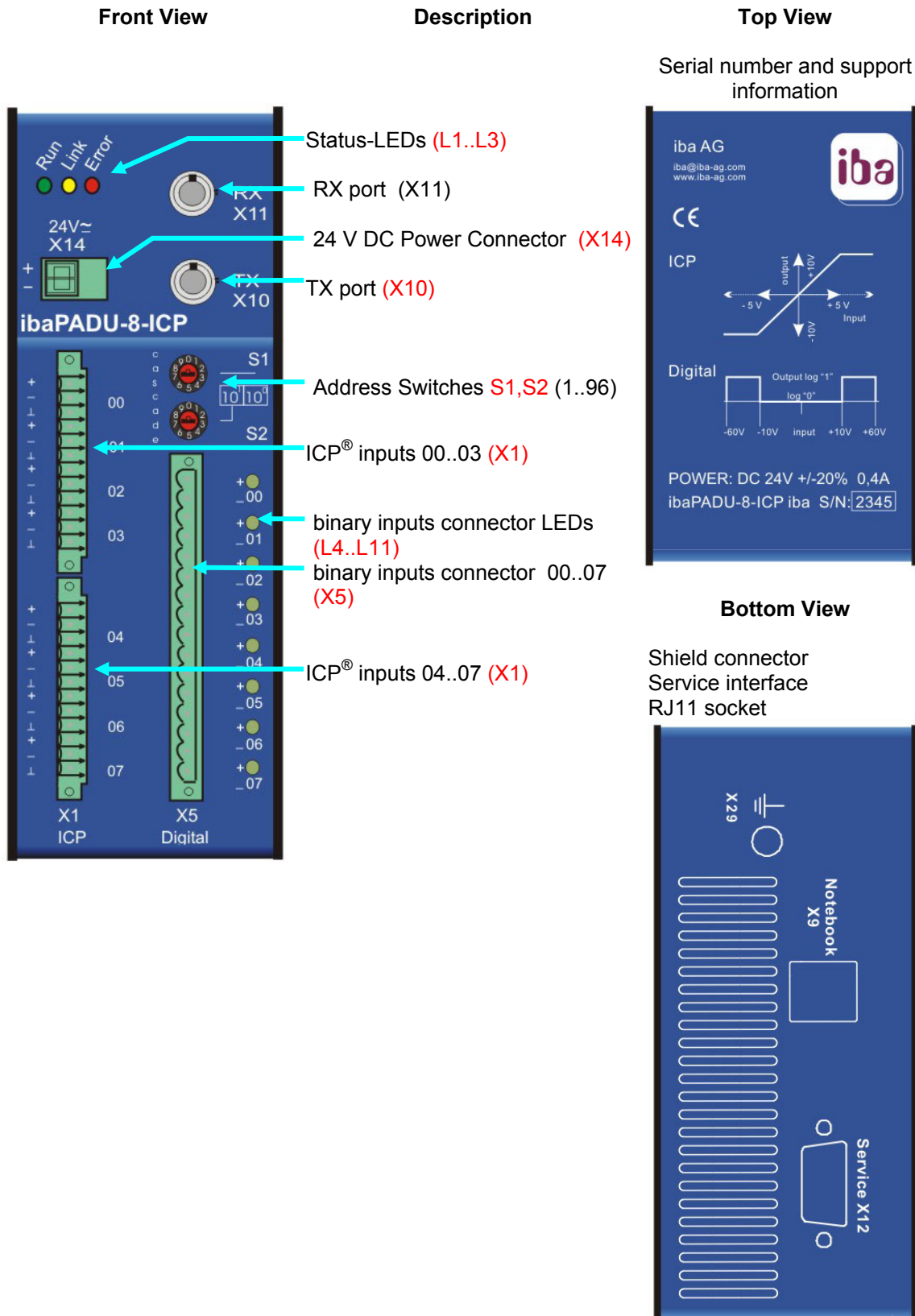

7.2.1 Power Supply Connection

Phoenix 2-pole terminal is used to connect the power supply. An unstabilized DC voltage between 18 V and 32 V can be applied.

7.2.2 Fiber-optic Ports RX and TX

Two fiber-optic ports, labeled RX and TX, must be interconnected in a ring structure with other ibaPADU-8-ICP devices and the ibaFOB-card links. Connect the TX port of the iba FOB-card to the RX port of the first ibaPADU-8-ICP device in the ring. Then, connect the TX port of this ibaPADU-8-ICP device to the RX port of the next ibaPADU-8-ICP device in the ring. Continue until all of up to 96 ibaPADU-8-ICP devices are interconnected. Finally, connect the TX port of the final ibaPADU-8-ICP device to the corresponding RX port of the ibaFOB-card.

7.2.3 Setting the Device Address with S1 and S2 Decade Switches

Using a precision screwdriver or other suitable instrument, turn the S1 decade switch to the ones digit of the desired device address and then turn the S2 decade switch to the corresponding tens digit of the desired device address. This defines the address of the device within the ibaFOB-card link. (e.g. address = 32; set S1 = 2, S2=3)

7.2.4 Terminal Blocks Pin Connections X1, X5, X14

Note: the counting order is from the top to the bottom.

Power Supply X14

Pin	Connection
1	+24 V
2	0 V

ICP[®] Analog Connector Pin Connections X1

Each ibaPADU-8-ICP supports 8 ICP[®] analog type inputs and 8 binary inputs. The pin connections are made as described in the tables below.

Pin	Upper Connector	Lower Connector
1	+ channel 0	+ channel 4
2	- channel 0	- channel 4
3	shield	shield
4	+ channel 1	+ channel 5
5	- channel 1	- channel 5
6	shield	shield
7	+ channel 2	+ channel 6
8	- channel 2	- channel 6
9	shield	shield
10	+ channel 3	+ channel 7
11	- channel 3	- channel 7
12	shield	shield

Binary Terminal Block Pin Connections X5

Pin	Connector
1	+ channel 0
2	- channel 0
3	+ channel 1
4	- channel 1
5	+ channel 2
6	- channel 2
7	+ channel 3
8	- channel 3
9	+ channel 4
10	- channel 4
11	+ channel 5
12	- channel 5
13	+ channel 6
14	- channel 6
15	+ channel 7
16	- channel 7

7.2.5 Run, Link and Error LED Indicators

LED	Status	Indication
Run (green)	Blinking	power is on and device is healthy
	Off	no power
Link (yellow)	Off	No incoming data stream (PC is inactive or the previous device in the chain is defective)
	On	data is being received at RX (not active in multiplex mode)
	Blinking	bidirectional connection from the device to FOB-io (active in multiplex mode)
Error (red)	On	device error
	Off	device healthy, automatically resets when error condition ends

7.2.6 Binary LED Indicators

LED	Status	Indication
Ln : (green)	On	Binary input is true (log „1“)
	Off	Binary input is false (log „0“)

n = 4..11 (4 corresponds to binary input 00; 11 to binary input 07)

7.2.7 Service Interface



Note

Firmware may only be updated by iba!

A 9-pin SUB-D port, found on the under side of the device, may be used to load new firmware for the device. New firmware is loaded via a V.24 interface. Please contact iba regarding loading new firmware.

The firmware will be loaded via the pins 2, 3, 5 and the bootpin (7). At first, the device must be set into boot mode by applying 0 V to the bootpin and then the device must be booted (switch off and on the power supply). Now the device is in boot mode and accepts the new firmware. Afterwards the V.24 cable has to be removed (or apply 5 V to the bootpin) and the device has to be rebooted. The device is now booting with the new firmware.



Under normal service conditions, the V.24 cable must not be connected.

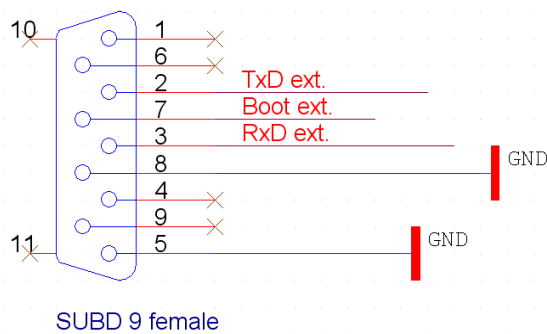

Service Interface Pinout Diagram

7.2.8 Shield Connector for Physical Earth

Proper connection of cable shielding to the device should be ensured. The shield connector found on the underside of the device should be connected with any total shield that serves for all sensor cables. In addition, each individual sensor channel shield must be connected to its respective input channel shield pin.



Note

Sensor cable shield should be connected only on the ibaPADU-8-ICP side in order to avoid ground loops with the sensor housing.



Note

Always ground the DIN rail on which the device is installed.

8 System integration

As far as no special relation to a PC board is necessary the ibaFOB-S-, -D- or -Dexp-cards are referred to as ibaFOB card.

ibaPADU-8-ICP devices are interconnected in a ring structure with the ibaFOB serving as a central controller for all connected devices. Each link on the ibaFOB card has a TX/RX port for transmission of control signals and reception of data from connected ibaPADU-8-ICP devices. All devices connected in each fiber-optic link must have unique addresses.

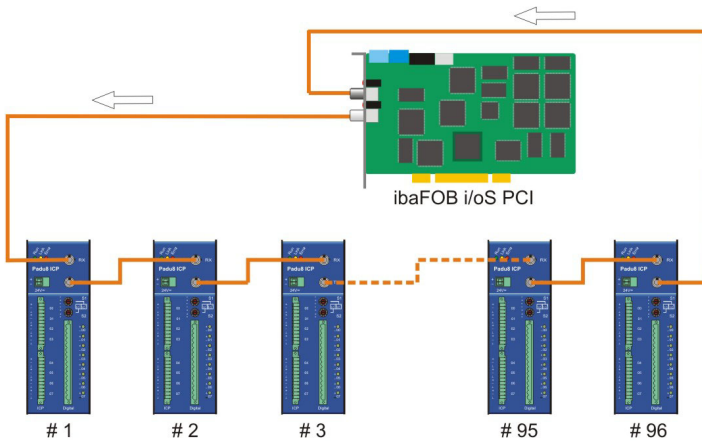

Figure 1. Ring topology

The TX port on an individual ibaFOB interface must be connected to the RX port on the first ibaPADU-8-ICP in the fiber-optic ring. Installed devices may be interconnected in any order (consecutive addresses are not required) provided that all devices have unique address settings (0...95). The TX port on the last device in the chain must be connected to the RX port on the respective ibaFOB interface card.



Important note

This ring topology is only supported by ibaLogic-V3, since numbering of the devices can be done automatically in ibaLogic-V3.

The ring topology can also be used in ibaPDA or ibaScope, but the automatic numbering is not possible. The user has to change the device number and to restart the acquisition. Therefore this topology is not advisable for continuous measuring.

8.1 Process Monitoring Topology Example

Figure 2 depicts a possible topology for process monitoring of mill chatter. In this configuration, up to 4 ibaPADU-8-ICP can be simultaneously sampled at up to 25 kHz. Each ibaFOB link can support a single ibaPADU-8-ICP. Maximum 32 (analog ICP® and binary) channels can be sampled continuously using this topology. For continuous process monitoring, multiplex operation of the device network is not required.

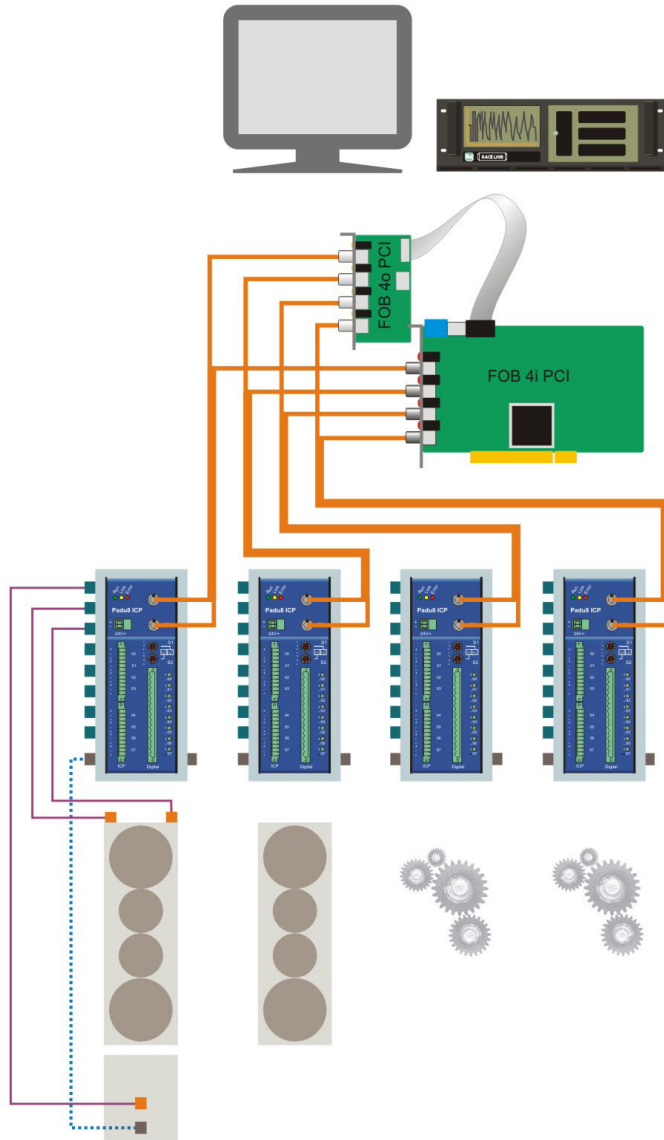

If an ibaPADU-8-ICP is connected with a fiber optic link of an ibaFOB card, no other PADU type can be connected to the same link. But it is allowed to use other devices on the other links since the fiber optic links on one card can work in different modes.

It is possible to couple other process signals using other input devices available from iba, in which case the corresponding interface must be available.

For example, ibaPADU-8 devices can be used to monitor the process state and indicate that high-speed, ibaPADU-8-ICP monitoring is required.

Figure 2. Star Topology

8.2 Online Machine Condition Monitoring Topology

Figure 3 depicts a possible topology for online machine condition monitoring. In this configuration, up to 4x96 ibaPADU-8-ICP can be sampled in a multiplexed fashion to provide up to 3136 online channels per monitoring station. Each ibaFOB link can support up to 96 ibaPADU-8-ICP, measuring one at a time.

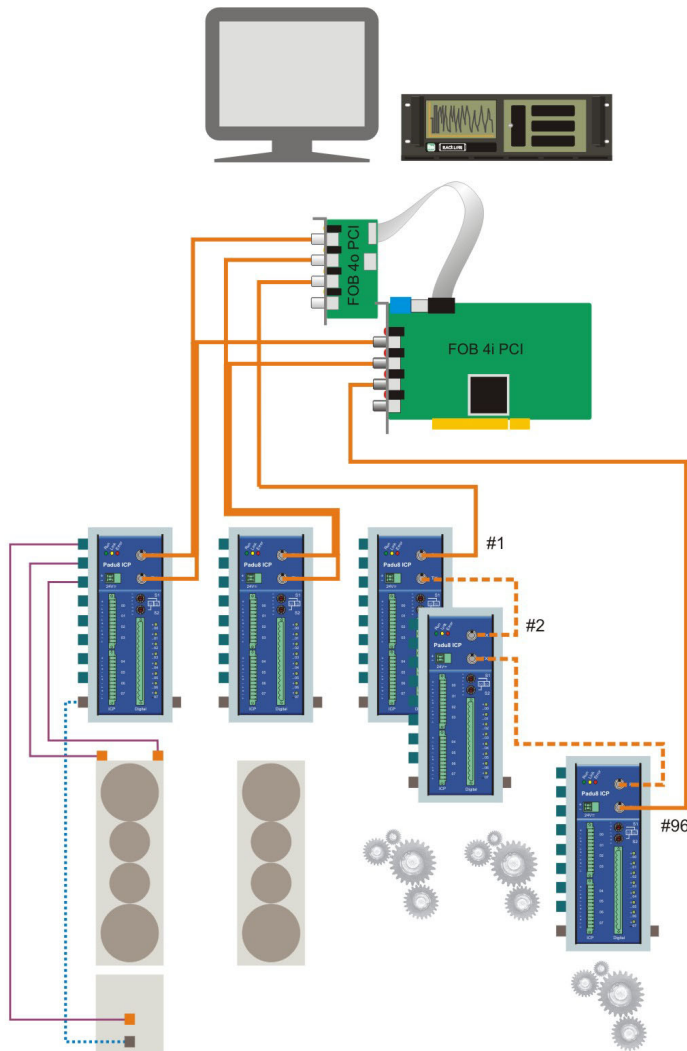

Figure 3 System Topology for Online Machine Condition Monitoring

Even in the branch with multiplexed ibaPADU-8-ICP devices only one device can be used at a time.

The selection of the devices which signals shall be captured can be automatically done in ibaLogic or manually in ibaScope or ibaPDA.

If an ibaPADU-8-ICP is connected with a fiber optic link of an ibaFOB card, no other PADU type can be connected to the same link. But it is allowed to use other devices on the other links since the fiber optic links on one card can work in different modes.

For example, ibaPADU-8 devices can be used to monitor additional process variables.



Note

The use of the ibaBM-FOX-i-3o splitter in conjunction with ibaPADU-8-ICP is not supported.

Due to the bidirectional data transfer between ibaPADU-8-ICP and ibaFOB-card it is not possible to split the signals.

If a multiplication of signals is required, please contact iba.

9 Programmable Settings of the Device

Each ibaPADU-8-ICP is programmable. A single, common sampling rate for all channels may be set. Each ICP[®] input channel has a programmable gain and filter setting as well.

9.1 Sampling Rate

The sampling rate can be programmed via the ibaFOB interface in steps of 50 nanoseconds from 40 μ s (25 kHz) to 2 ms (500 Hz). The chosen sample rate is then common for all channels, analog and digital.

9.2 Input Gain

The following table displays the possible gain settings for an ICP[®] input channel. Notice that for small gain values, incremental steps of 0.5 dB are possible. After about 40 dB, the steps are larger from 1 dB to 6 dB at the end of the scale. Because the device may not reach a gain that is requested via an ibaFOB telegram, the device returns the actual gain setting when measurements begin.

Table 1. Possible Input Gains

0.0	0.5	1.0	1.5	2.0	2.5	3.0	3.5	4.0	4.5	0.5 dB step area
5.0	5.5	6.0	6.6	6.9	7.5	8.0	8.4	9.1	9.6	
9.9	10.5	11.1	11.4	12.0	12.4	13.2	13.6	14.0	14.4	
14.9	15.4	15.9	16.5	17.1	17.7	18.4	19.2	20.0	20.5	
21.0	21.5	22.0	22.5	23.0	23.5	24.0	24.5	25.0	25.5	
26.0	26.6	26.9	27.5	28.0	28.4	29.1	29.6	29.9	30.5	
31.1	31.4	32.0	32.4	33.2	33.6	34.0	34.4	34.9	35.4	
35.9	36.5	37.1	37.7	38.4	39.2	40.0	40.9	41.9	43.1	
44.4	46.0	48.0	50.5	54.0	60.0					
										bigger steps



Tip

Typical ICP[®] circuits have a settling time of 3-4 seconds after gain changes. This is also true when the sensor saturates the circuit.



Note

With an input gain of 40 dB and higher, the signal/noise ratio quickly deteriorates. This can be an indication that a more sensitive sensor is required, e.g. 1000 mV/g instead of 100 mV/g.

9.3 Low-Pass Filter

A programmable 72 dB 6-pole low-pass filter is implemented on each ICP[®] channel. Commands sent from the ibaFOB are used to set this filter frequency.

The frequency range for the low-pass filter is 0.5 Hz ...25 kHz.

Specification		Example	
Range (Hz)	Accuracy	Reference (Hz)	Actual Value (Hz)
100-250	1 %	126	126,3
250-500	1 %	270	270,3
500-1000	1 %	990	990,1
1000-10000	10 %	3750	3773,6
10000-25000	10 %	21500	22222



Tip

The programmable digital filter produces modulation component frequencies with < 72 dB of the maximum signal strength. Therefore, the analysis software should take this into account.



Tip

At corner frequencies < 1000 Hz, reflected frequencies above 50x the corner frequency are possible.

Example 1: $f_c = 100$ Hz

reflected frequency band starts at $50 \times 100 = 5000$ Hz. A signal frequency of 5100 Hz would be noticeable at 100 Hz.

Example 2: $f_c = 1000$ Hz

reflected frequency band starts at $50 \times 1000 = 50000$ Hz. A signal frequency of 51000 Hz would be dampened 6 dB by the static low-pass filter. This signal would be noticeable for signal strengths above 20 dB.

If a device for low-frequency applications should be required, iba can supply a variant of this device for sampling at 1 kHz or less, with a static low-pass filter. Please contact iba for further details.

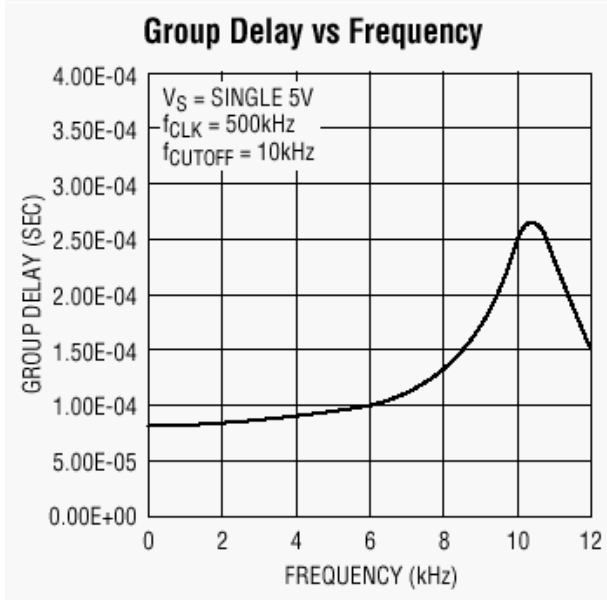
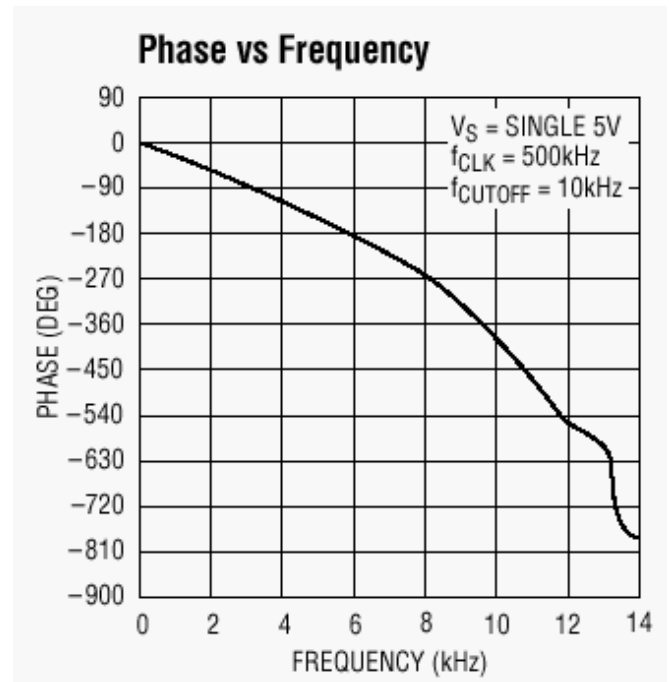
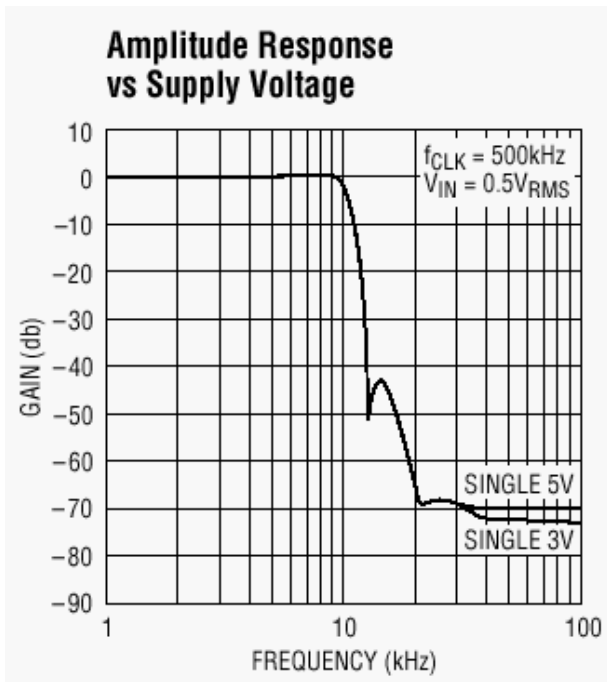

These diagrams show the characteristics of the used programmable input filter.

The filter itself causes a delay within the ibaPADU-8-ICP. This delay is named Group delay.

At an edge frequency of 1 kHz this delay is approx. 80 μs (see left.)

10 Configuration

ibaPADU-8-ICP is actually supported ibaLogic-V3, ibaScope and ibaPDA-V6 software. The following chapters describe example configurations in ibaLogic and ibaPDA. The settings in ibaScope correspond to the settings in ibaLogic, although the dialogs are slightly different. For setup of the device with ibaScope please refer to the ibaScope manual.

10.1 Working with ibaLogic-V3

With ibaLogic you may analyse 25 kHz signals. By using additional (slow) process variable you may define monitoring ranges.

In order to conceive and analyse the behaviour of dynamic processes which are much faster (40 μ s) than the usual time base of ibaLogic (1 ms) the data type Array is used by ibaLogic.

In the following you will find a short description of installation and application of the device.

10.1.1 Typical Configuration

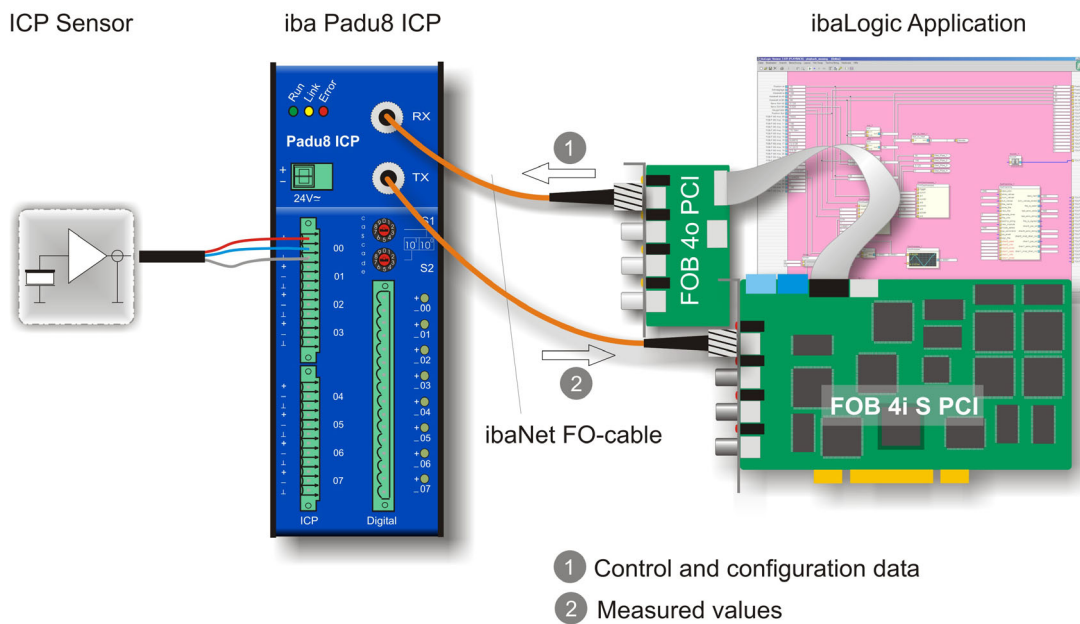

Figure 4 Configuration with ICP[®]-Sensor

10.1.2 Hardware Settings

The connection between ibaPADU-8-ICP and the software application on the PC is the ibaFOB-io-S-board or the combination of ibaFOB-4i + ibaFOB-4o.

Please note to connect the fiber optic links to the corresponding ports on the ibaFOB-4i and –FOB-4o card (same order top-down), e.g. as shown in Figure 4 above.

Modes of Operation FOB-F and FOB-M

In contrary to previous interface cards, the modes of operation are set by software means. In ibaLogic there are corresponding dialogs.

Basically, there are two operational modes: FOB-F and FOB-M.

FOB-F is the mode of operation for usual data acquisition with the major part of iba devices such as PADU-8, -16, -32, ibaLink-SM-64-io, ibaLink-SM-128V-i-2o, ibaNet750-BM etc. The fastest sample rate is 1 kHz (1 ms). You may use ibaPDA, ibaLogic or ibaScope as software application. When using ibaLogic, only an asynchronous mode is possible, i.e. ibaLogic can not be synchronized by the ibaPADU-8-ICP.

The FOB-M mode is used for fast data acquisition with sample rates of up to 25 kHz (40 ms). Running in FOB-M mode, the ibaFOB-card can only work with devices ibaPADU-16-M, ibaPADU-8-M or –ICP. Only ibaLogic or ibaScope can be used for software application. The operation in a synchronous mode, i.e. with synchronising multiple systems, is possible with ibaScope only.

Menu “File - System Setup - FOB-IO / FOB-M”

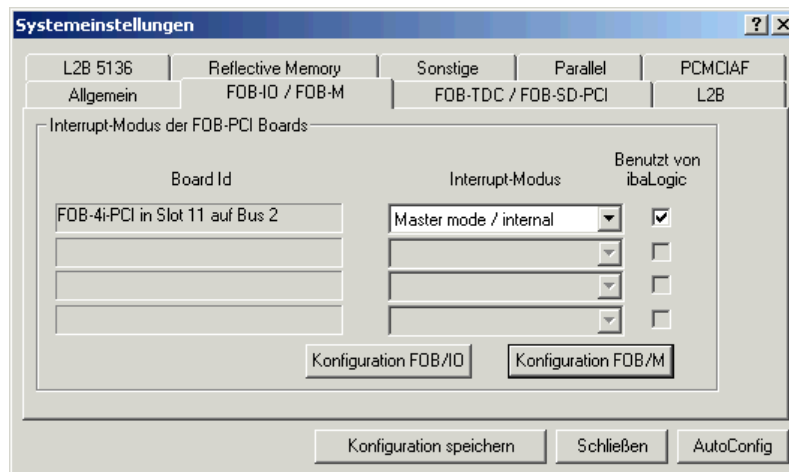

The checkbox “Used by ibaLogic” must be checked for FOB-card which is connected to the ibaPADU-8-ICP.

Then click on button <Configuration FOB I/O> to open the setup dialog for the FOB-card.

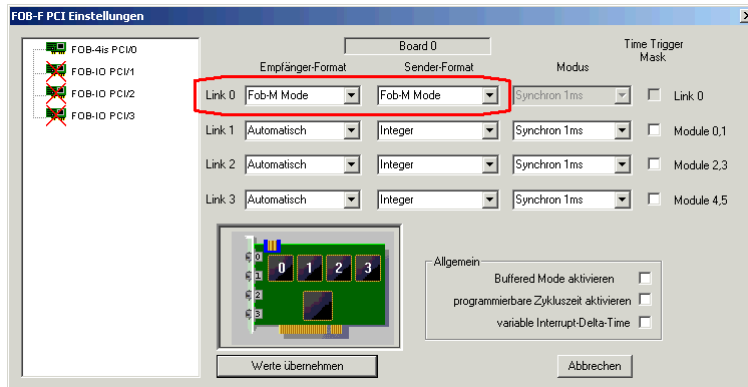

Select the corresponding FOB-card in the tree on the left side. On the right side you see the settings of the selected card. Choose the line of the link which is connected to the ibaPADU-8-ICP and select **FOB-M Mode** in the fields for both “Receiver Format” and “Sender Format” from the pick-list. Then click on <Apply> button.



Tip

You will get into the same dialog via menu “File - PCI-Configuration - FOB-IO-PCI Link Settings”. Instead of the <Apply> button you will find the button <Save configuration> which in fact has the same function.

There is a second button <Configuration FOB/M> in the dialog “System Settings - FOB-IO / FOB-M” which opens the dialog for the preset of several parameters for FOB-M mode operation.

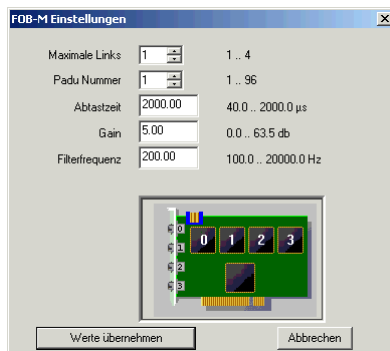

You may provide presets for the listed parameters but usually the parameters are provided during operation by the software application, e.g. ibaLogic. The parameter setting from the application overwrites the presets of this dialog.



Tip

You will get into the same dialog via menu “File - PCI-Configuration - FOB-M-PCI Link Settings”. Instead of the <Apply> button you will find the button <Save configuration> which in fact has the same function.

10.1.3 Checking the Communication with the Help of ibaDiag

Start the diagnostics program over menu “Hardware - ibaDiag”.

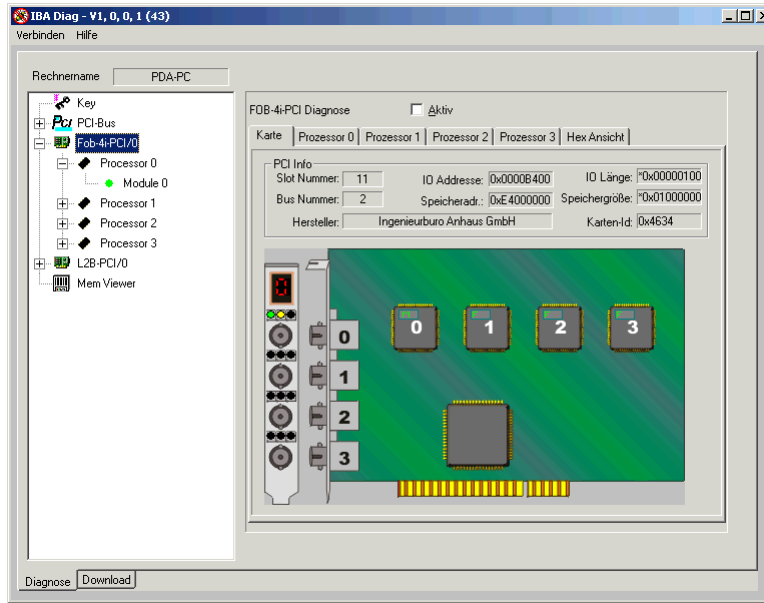

Select the FOB-card which is connected to the ibaPADU-8-ICP in the tree on the left side.

On the right side you see a simplified representation of the card with the 7-segment-display for the card address of this type and the LEDs showing the status of every link. The physical connection is ok if the green LED is flashing and the yellow LED is on. Telegrams are received by ibaPADU-8-ICP and the communication in output direction, from ibaFOB-4o to the ibaPADU-8-ICP is working too.

On the next lower level, branch “Processor” you will find much information about the ibaPADU-8-ICP, or ibaPADU-8-M respectively, which is partly only relevant for service purposes.

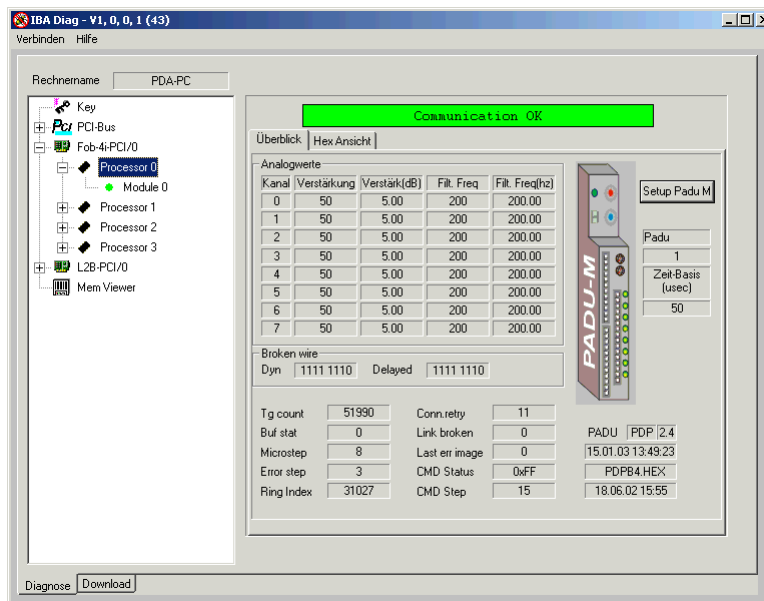

The message display on top should show “Communication OK” on green ground.

The graphical representation of the ibaPADU-8-M device is not animated.

The large table on the left side and the fields on the right side of the PADU picture show the settings of the Padu setup. If the FOB card is set to active mode by means of ibaDiag, which is only possible when ibaLogic is not running at this time, you may call the Padu setup dialog window by clicking on the button <Setup Padu M>.



Other documentation

For a more detailed description of the diagnostic functions and parameters please refer to the ibaDiag manual which can be downloaded from our website.

Finally, there is another level in the tree with more information, the module level.

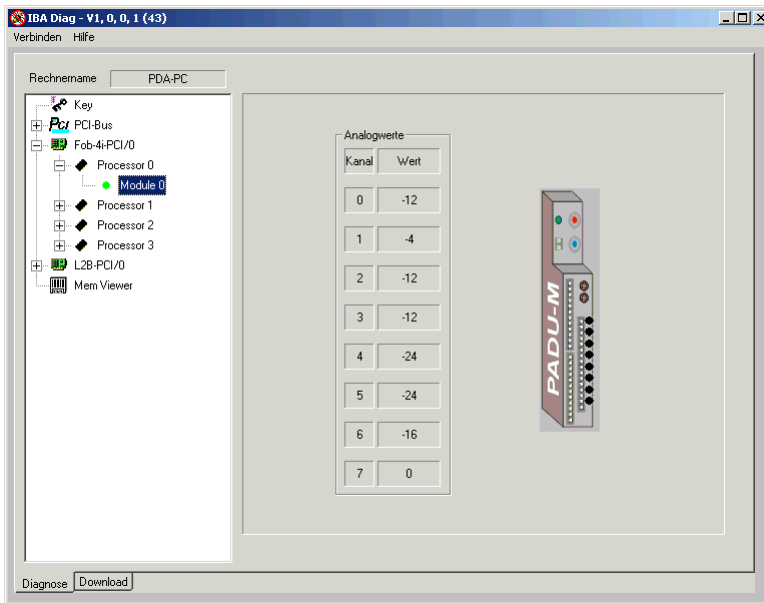

In this view you may already see measured values running. By the way, this is working independently from a software application such as ibaLogic or ibaScope.

Close the ibaDiag window in order to return to the next steps of the setup.

10.1.4 Input Resources iba FOB-M/IN

The following table shows the input resources of the first link on the first ibaFOB-card. Up to four ibaFOB-4i cards with four links each are possible.

For further information please refer to the ibaLogic manual.

The device provides actual measured values and actual parameter settings in return as well.

FobM In Link0 Padu-Number	1
FobM In Link0 Sample time	40
FobM In Link0 Gain 0	20.1
FobM In Link0 Gain 1	20.1
FobM In Link0 Gain 2	20.1
FobM In Link0 Gain 3	0
FobM In Link0 Gain 4	0
FobM In Link0 Gain 5	0
FobM In Link0 Gain 6	0
FobM In Link0 Gain 7	0
FobM In Link0 Frequency 0	5010
FobM In Link0 Frequency 1	5010
FobM In Link0 Frequency 2	5010
FobM In Link0 Frequency 3	100
FobM In Link0 Frequency 4	100
FobM In Link0 Frequency 5	100
FobM In Link0 Frequency 6	100
FobM In Link0 Frequency 7	100
FobM In Link0 RCMD/CMDEX	-192
FobM In Link0 CMD	-192
FobM In Link0 Int. 0	16
FobM In Link0 Int. 1	0
FobM In Link0 Int. 2	-12
FobM In Link0 Int. 3	-12
FobM In Link0 Int. 4	-20
FobM In Link0 Int. 5	-24
FobM In Link0 Int. 6	-20
FobM In Link0 Int. 7	-8
FobM In Link0 Dig. 0	FALSE
FobM In Link0 Dig. 1	FALSE
FobM In Link0 Dig. 2	FALSE
FobM In Link0 Dig. 3	FALSE
FobM In Link0 Dig. 4	FALSE
FobM In Link0 Dig. 5	FALSE
FobM In Link0 Dig. 6	FALSE
FobM In Link0 Dig. 7	FALSE
FobM In Link0 Data Available	
FobM In Link0 Data Size	512
FobM In Link0 Link Available	
FobM In Link0 Link Measuring	
FobM In Link0 Data Lost	
FobM In Link0 Data Overrun	
FobM In Measurement Active	

Number of the activated ibaPADU-8-ICP (0..95)
Sample time of the activated device in μ s

Actual gain of the channels
in dB for channels 1..8

Actual corner frequency of low-pass filter
for channels 1..8

Actual reset status
Actual command being processed

Measured values of analog channels 1..8
(signed integers)

Measured values of binary channels 1...8

Status of data buffer (true, if number of values > buffer size)
Quantity of available data (multiples of 10), if data available.

Link status (true, if iba FOB M active and link available)

True, if link status ok and ibaPADU-8-ICP activated.

True, if data reading speed was too slow.

True, if data overflow. Data acquisition will be stopped!

True, if data acquisition is running.

10.1.5 Output Resources for iba FOB-M (FOB-M/Out)

The board ibaFOB-io-S provides one bidirectional fiber optical link, the ibaFOB-4i-S together with ibaFOB-4o four links, respectively. Up to four ibaFOB-4i-S / 4o boards are supported by ibaLogic (= max. 16 optical links with up to 96 ibaPADU-8-ICP devices each).

On each link only one ibaPADU-8-ICP can be activated and parameterized at a time. In order to change parameters or to activate another device on the link respectively, the current measurement must be stopped. After, the new parameters can be transferred to the device. Please note, that the device will need a few seconds to adapt to the new parameters. After parameterization the device sends a continuous data stream to ibaLogic. Please note further that the change of parameters may affect the processing of other in- and output resources due to a halt of the drivers (lack of some cycles). Thus, ibaLogic is to be used preferably in continuous operation with few ibaPADU-8-ICP devices which are constantly used (e.g. applications for test stands, turbines, compressors).

Number of ibaPADU-8-ICP device to be activated	<input type="text" value="0"/>	<input type="checkbox"/>	FOB-M LO PaduNumber
Desired sample time of this device	<input type="text" value="0"/>	<input type="checkbox"/>	FOB-M LO Sampletime
/	<input type="text" value="0"/>	<input type="checkbox"/>	FOB-M LO Gain0
	<input type="text" value="0"/>	<input type="checkbox"/>	FOB-M LO Gain1
	<input type="text" value="0"/>	<input type="checkbox"/>	FOB-M LO Gain2
	<input type="text" value="0"/>	<input type="checkbox"/>	FOB-M LO Gain3
Desired gain setting	<input type="text" value="0"/>	<input type="checkbox"/>	FOB-M LO Gain4
for channels 1..8 (0..63 dB)	<input type="text" value="0"/>	<input type="checkbox"/>	FOB-M LO Gain5
	<input type="text" value="0"/>	<input type="checkbox"/>	FOB-M LO Gain6
	<input type="text" value="0"/>	<input type="checkbox"/>	FOB-M LO Gain7
/	<input type="text" value="0"/>	<input type="checkbox"/>	FOB-M LO Freq0
	<input type="text" value="0"/>	<input type="checkbox"/>	FOB-M LO Freq1
	<input type="text" value="0"/>	<input type="checkbox"/>	FOB-M LO Freq2
	<input type="text" value="0"/>	<input type="checkbox"/>	FOB-M LO Freq3
Desired low pass filter corner frequency	<input type="text" value="0"/>	<input type="checkbox"/>	FOB-M LO Freq4
for channel 1..8 in Hz.	<input type="text" value="0"/>	<input type="checkbox"/>	FOB-M LO Freq5
	<input type="text" value="0"/>	<input type="checkbox"/>	FOB-M LO Freq6
	<input type="text" value="0"/>	<input type="checkbox"/>	FOB-M LO Freq7
Trigger for parameter transfer to the device	<input type="checkbox"/>	<input checked="" type="checkbox"/>	FOB-M LO Params Takeover
Reset the connected optical link.	<input type="checkbox"/>	<input checked="" type="checkbox"/>	FOB-M LO Reset Link
Request data from the selected device.	<input type="checkbox"/>	<input checked="" type="checkbox"/>	FOB-M LO Data Request
Desired block size for data transmission	<input type="text" value="0"/>	<input type="checkbox"/>	FOB-M LO Datasize
(will always be rounded to a multiple of 10, max. = 2500)		<input checked="" type="checkbox"/>	FOB-M LO Select
Activate this link for measurement.		<input checked="" type="checkbox"/>	FOB-M Measurement Start
Start measurement (data acquisition)		<input checked="" type="checkbox"/>	

10.1.6 Control of ibaPADU-8-ICP in ibaLogic application program

In order to work with the ibaPADU-8-ICP, the device must be supplied with some control data from the application software. With ibaScope a part of the date is supplied automatically.

When using the device with ibaLogic the required parameters must be evaluated in the application and transferred to the device over the FOB-M output resources.

First, these are the values for gain and frequency for each channel to be used. The values depend on the measurement arrangement and sensor types.

For the supply of the other parameters iba developed a sample function block FOBM_Control which is available from iba on request.

The use of this function block is described by means of a sample application (layout).

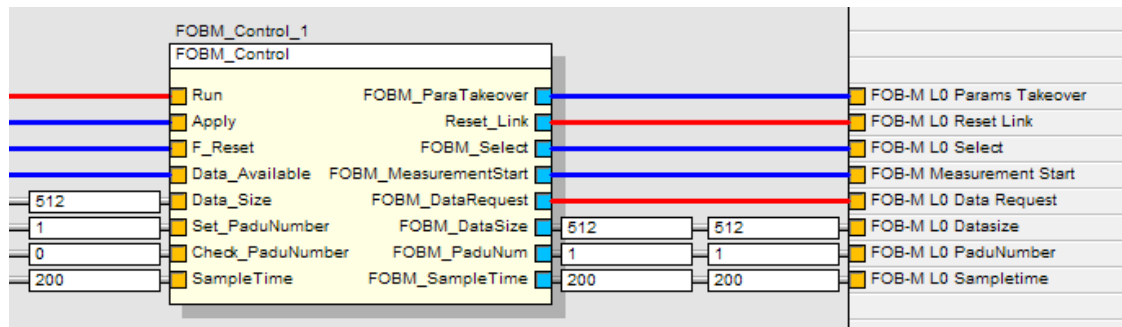

The inputs Run, Apply and F_Reset are set by the application and control the processing, the takeover of new parameters and the resetting.

The application also evaluates the values for Data_Size, Set_PaduNumber, Check_PaduNumber and SampleTime.

The input Data_Available is directly linked to the input resources (FOBM In Link 0 Data Available).

10.1.7 Data Buffer Size

In order to grant the proper operation with continuous data streams, there are several buffers of fixed size. (This is not important in case of single measurements)

iba -M buffer size:	1.024 values per measuring channel.
Driver buffer size:	25.000 values per measuring channel.
ibaLogic buffer size:	50.000 values per measuring channel.

Theoretical approach to the relation between continuous data streaming and ibaLogic task cycle.

ibaPADU-8-ICP-sample time	e.g. 40 μ s
Quantity of data to be read	e.g. 2050 values
Data-reading interval (in ibaLogic)	e.g. 25 ms
$1 / 25 \text{ ms} \times 2050 = 82.000 \text{ values/sec/channel}$	Data read rate (DRR)
$1 / 40 \mu\text{s} = 25.000 \text{ values/sec/channel}$	Data generation rate (DGR)



Note

The data read rate must be at least three times the data generation rate!

This is required in order to avoid data loss during online operation in case of temporary inhibited ibaLogic cycles.

10.2 Configuring with ibaPDA

This chapter describes the signal configuration and selection with ibaPDA-V6.



Other documentation

For the general use of ibaPDA, see the manual "ibaPDA-V6".

After installing ibaPDA and starting the ibaPDA client, select "Configure – I/O Manager..." in the main menu.

10.2.1 Configuring ibaPADU-8-ICP:

1. If several iba PCI cards are used in ibaPDA, set the board connected to ibaPADU-8-ICP to the interrupt mode "Master internal" and set the option "In use".

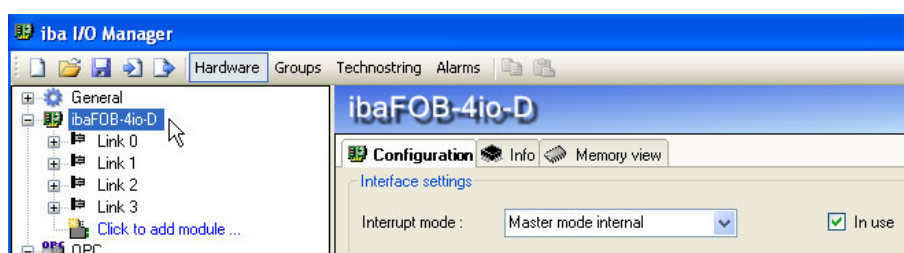

2. Create the device module by one of the following actions:

- ❑ Press the icon "New configuration" .

When the device is connected correctly, the "autodetect" feature will find the ibaPADU-8-ICP and place module "Padu 8-ICP" on the connected FOB link. Alternatively right-click the link of the FOB-D or FOB-S card to which the ibaPADU-8-ICP is connected and select "Autodetect"

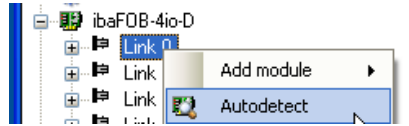

When the device is connected correctly to this link, the "autodetect" feature will find it and place modules "Padu 8-ICP" on this link.

- ❑ Right-click the link of the FOB-D or FOB-S card to which the ibaPADU-8-ICP is connected and select "Add module" - "Padu 8-ICP" from the submenu

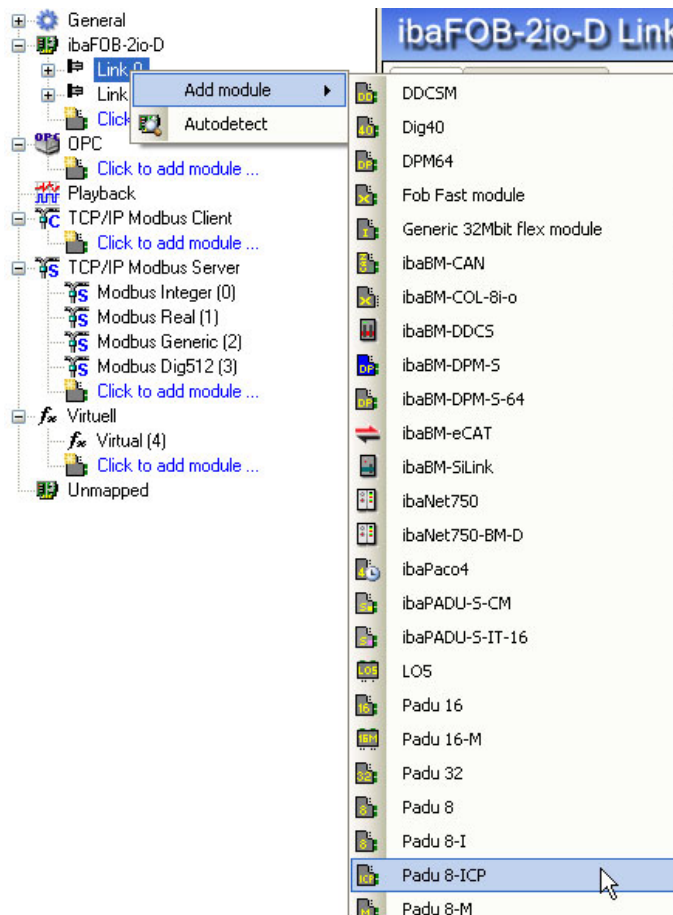

or click to the blue text link "Click to add module..." and select the Padu 8-ICP interface from the displayed list.

Result:

When the device is connected correctly with two bidirectional fibre optic links, the module is defined on the connected link. You see the communication status OK in the Info tab of the connected links.

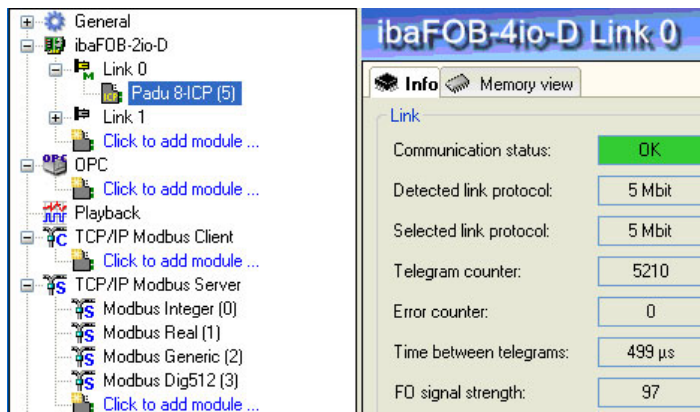

3. Define the general properties

- Select the General Tab.

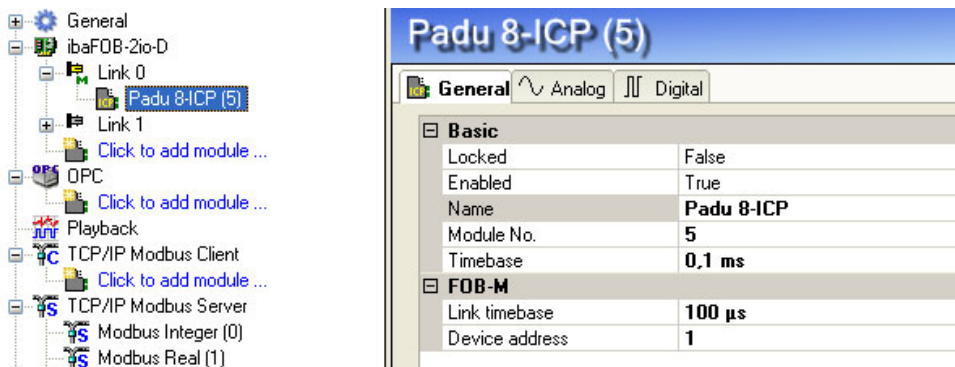

Whenever you click to a property field, you will see its description in the comment area at the bottom of the tab.

- Define the properties:

Basic:

- **Locked:** If true, the module can only be changed by authorized users.
- **Enabled:** If false, this module is excluded from acquisition.
- **Name:** Enter a comprehensive name for the module.
- **Module No.:** Enter a module number. ibaPDA gives numbers automatically in a chronological order. However, you may prefer a different order later in the data file for analysis. The module number determines the order in the signal tree in IbaAnalyzer.
- **Timebase:** An integer multiple of the FOB-M Link timebase, see below.

FOB-M:

- **Link timebase:** Set the time to a value between 40 µs and 2000 µs.
 Note: The Link timebase is valid for all other links that work in M mode.
 The module timebase (see above) must be equal or an integer multiple of this link timebase.
 Also, the general acquisition timebase of IbaPDA (configured in the *General* branch of the I/O manager tree) must be an integer multiple of the M mode timebase



Important information

Note that the difference between FOB-M link time base and general ibaPDA acquisition time base must not be too high to avoid exceeding the buffer limits. iba AG recommends a multiple between 25 and 100.

- Device address: address 0..95, according to the rotary switch settings S1 and S2.

4. Define the signal parameters.

- ☐ After selecting the tab "Analog", you can enter signal names and see actual values. The unit is predefined with "g".

Name	Unit	Sensitivity	Gain (dB)	Filter (Hz)	Active	Actual
0	g	100 mV/g	0	10000	<input checked="" type="checkbox"/>	0
1	g	100 mV/g	0	10000	<input checked="" type="checkbox"/>	0
2	g	100 mV/g	0	10000	<input checked="" type="checkbox"/>	0
3	g	100 mV/g	0	10000	<input checked="" type="checkbox"/>	0
4	g	100 mV/g	0	10000	<input checked="" type="checkbox"/>	0
5	g	100 mV/g	0	10000	<input checked="" type="checkbox"/>	0
6	g	100 mV/g	0	10000	<input checked="" type="checkbox"/>	0
7	g	100 mV/g	0	10000	<input checked="" type="checkbox"/>	0

- ☐ It is possible to define signal comments by clicking the button at the end of the name field.

- ☐ Sensitivity: Enter here the sensitivity according to the used ICP sensor.
- ☐ Gain: Choose a gain factor from the dropdown menu.

- ❑ Filter: Choose a corner frequency for the digital low-pass filter from the dropdown menu.

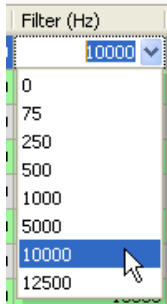

- ❑ You can also display other signal properties in the grid with a right mouse click on the headline of the grid.

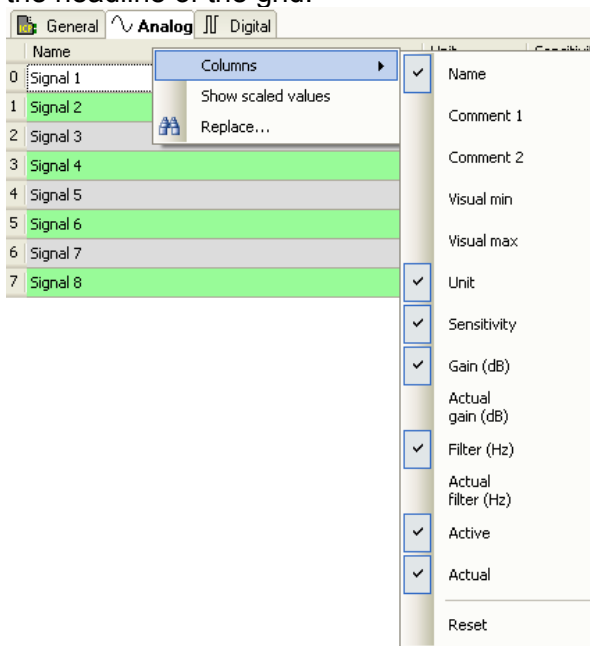

- ❑ In the same way, you can parameterize the digital signals.

5. To finish the configuration, press <OK> or <Apply>. The acquisition will start if all configured devices are connected correctly.

10.2.2 Configuring Triggers

Alternative to the definition of single trigger events, ibaPDA supports the definition of multiple trigger events as a trigger pool. For using the trigger pool you must first define all possible trigger events. In the 2nd step you must select the predefined events from the trigger pool to start and to stop storing the data.

1. Create Trigger Pool

- ❑ Start the I/O manager and add a trigger module under the interface "Virtual"

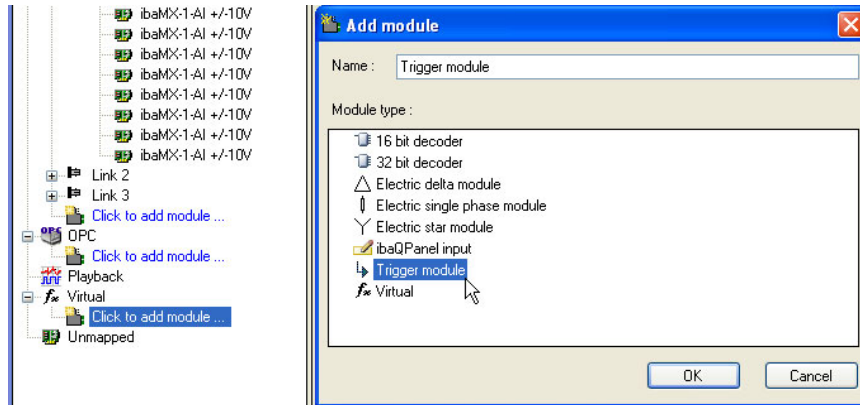

The trigger module is a virtual module with only digital signals. Each digital signal is a trigger. Instead of the normal expression builder the trigger module uses a special trigger builder dialog to create the expressions for the triggers. The trigger builder is based on the ibaScope trigger editor.

- ❑ Open the trigger builder by clicking on the expression builder icon of the digital signal.



- ❑ Define the trigger events

In the trigger properties you can set the name of the trigger and the comment. The expression of a trigger consists of one or more parts. Each part is an expression in itself. These parts are put together via the OR function. So the trigger will be 1 if one of its parts is 1.

The plus button will add a new part and the cross button will remove the currently selected part. The bottom part of the editor allows you to configure the currently selected part.

There are 4 standard functions that correspond to the ibaScope trigger functions and then there is an extra "custom" function where you can build your own expression.

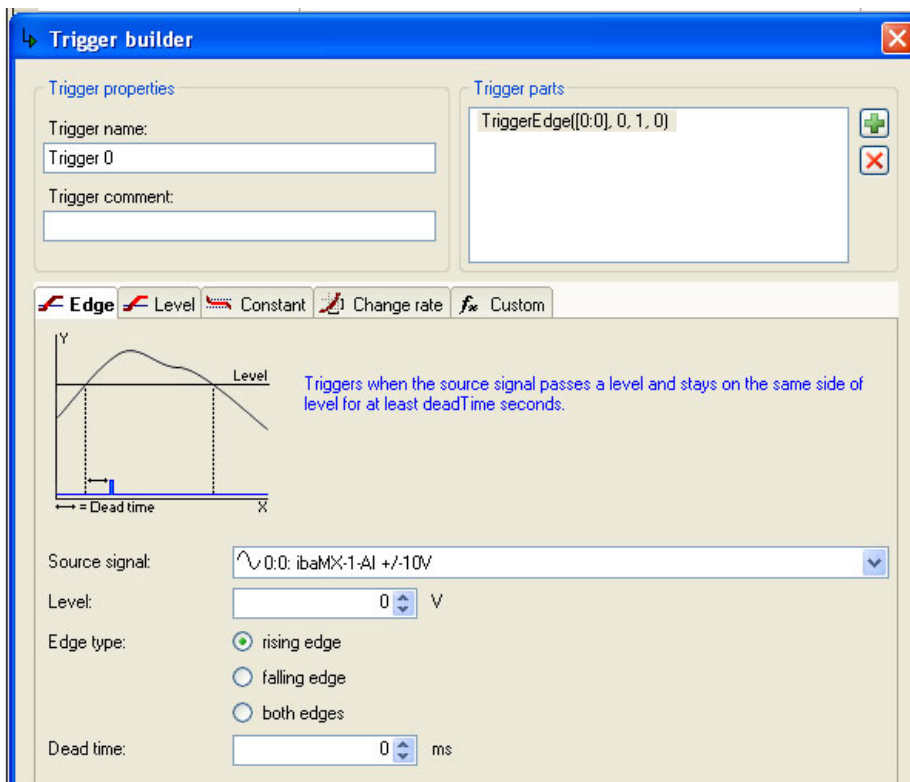

The custom tab contains the regular expression builder.

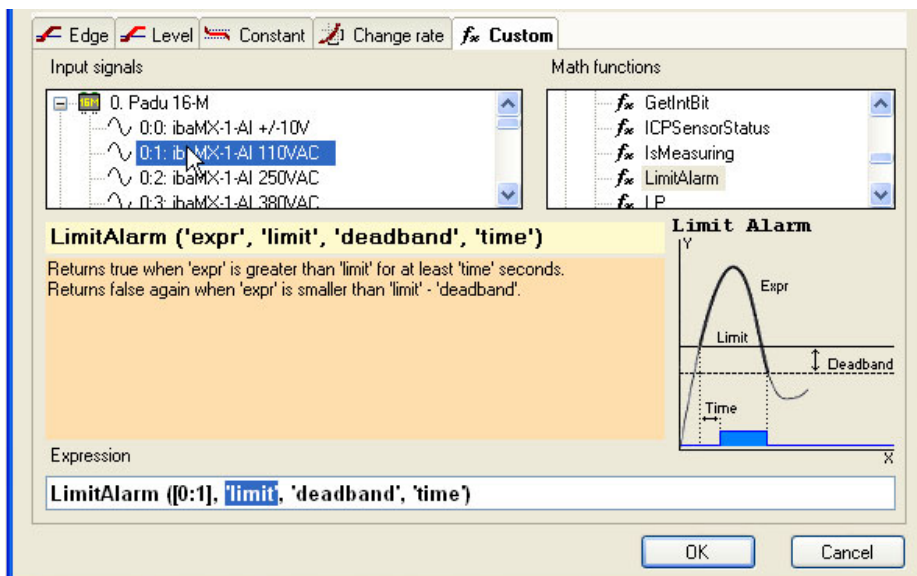

Finish the definition of one trigger event with <OK>

- ❑ Define further trigger events in the same way.

Result:

In the signal grid of the trigger module you see the overview of all defined trigger events.

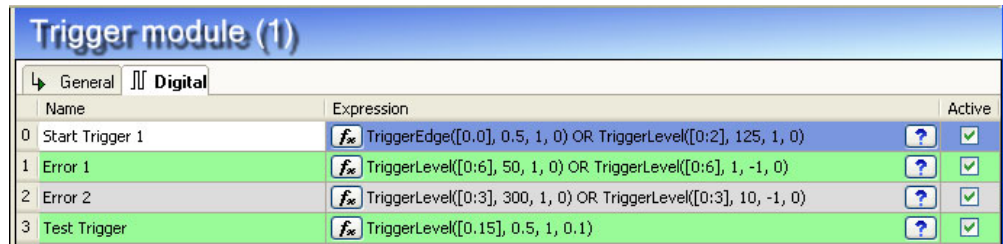

2. Use the trigger events in the data store configuration

The signals from the trigger modules can be used as triggers in the datastore. Each datastore has a start trigger pool and a stop trigger pool. A trigger pool is actually a list of signals from all trigger modules. If one of the triggers fires then the trigger pool fires. The trigger can fire on a rising edge of the trigger signals or it can fire each sample the trigger signal is 1.

- ☐ If you want to use a trigger pool as a trigger then you have to set this option on the trigger mode form for start trigger



- ☐ Use the checkboxes to select which trigger signals belong to the trigger pool.

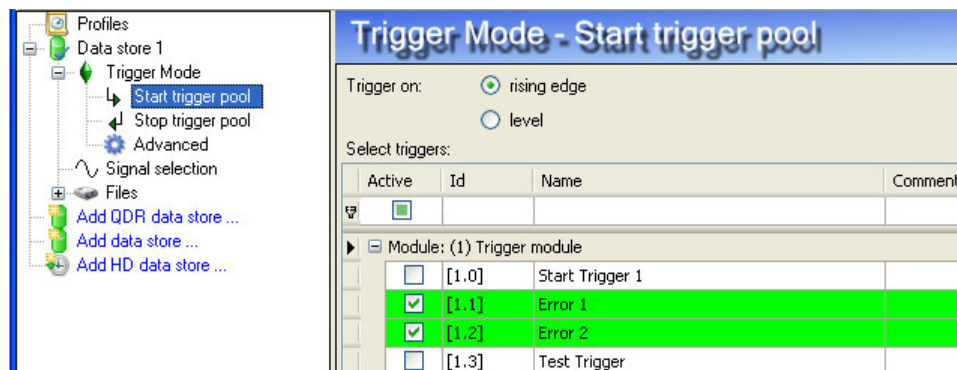

The selected trigger signals are marked green. The first row of the trigger grid can be used to filter the trigger signals. You can use multiselect via CTRL and SHIFT key to activate or deactivate multiple trigger signals at once.

- ☐ Do the same for the stop trigger

10.2.3 Configuring the Data Store

After finishing the configuration of the ibaPADU-8-ICP device, it is necessary to setup the data storage. For this, select "Configure – Data storage" in the main menu.

Proceed as follows:

1. Activate and name the data store

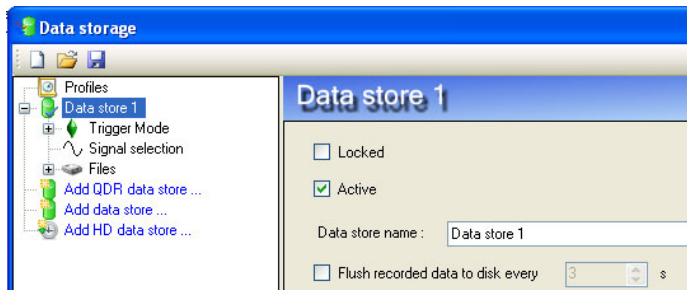

2. Define the Start / Stop Trigger
Either as a single trigger event,

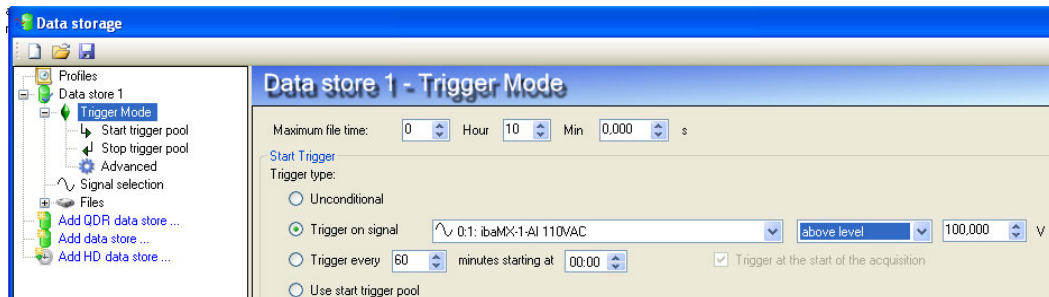

or one or more events from the trigger pool (see above).

3. Define the signals to store

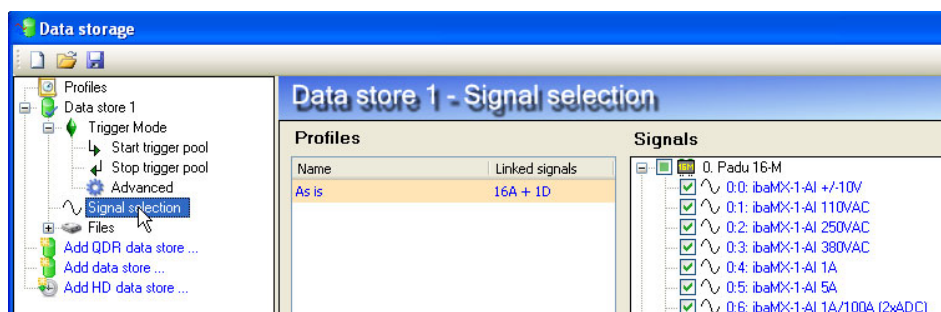



4. Define the data file properties
File name, location, directory organization etc.
5. To finish the configuration, press the button <OK> at the right bottom edge of the box. The data storage will be activated if the configuration is correct.

10.2.4 Configuring the Signal View

After closing the I/O Manager and the Data storage configuration you are in the ibaPDA client main view.

Mainly ibaPDA has three view types:

The trend graph , the Scope view  and the FFT view .

- Click to the icons to create the views in the signal monitor and place the dockable window in the monitor area.
- Drag and drop the signals from the signal tree and into the signal views.

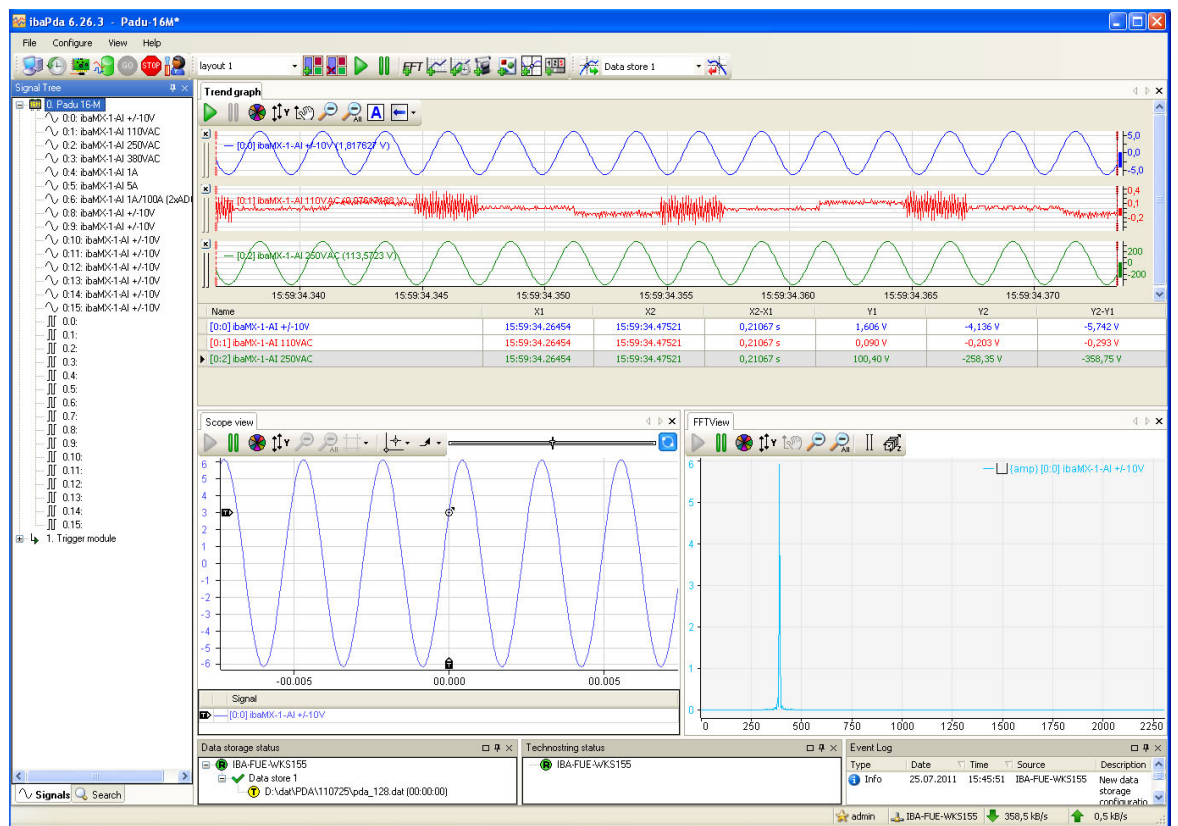

11 Technical data

Order number iba	10.120100
Mechanical stability and test parameters (all 3 axes)	DIN IEC 68-2-6; 1 g rms 90 Min @ 0..250 Hz / axis (all types) 2 g rms 90 Min @ 0..250 Hz / axis (all ibaPADU-8 types); ibaPADU-32-R 2 g`s with additional rear holder only !
EMI test parameters	EN 55011 (Class A); EN61000-4-6 (Class 3); EN61000-4-3/ENV 50204 (Class 3)
Operating temperature	0 °C to 50 °C (32 °F...122 °F),
Storage temperature	-25 °C to 70 °C (-13 °F...158 °F)
transport temperature	-25 °C to 70 °C (-13 °F...158 °F)
Cooling	Self cooling
Mounting	On DIN-rail, snap-on
Humidity Class	F no moisture
Protection Class	IP20
Power supply	24 V DC +/-20 % non stabilized
Power/Current consumption (w/o load)	typ. 300 mA, max. 400 mA; I _{OFF->ON} approx. 1A
Sampling rate programmable up to	25 kHz 8 channels simultaneously
FO-cable Coupling	62,5/125 µm ST Lean
Max. length of fiber optics between devices	2000 m (6560 ft)
Dimensions (WxHxD) [mm] ([inch])	54 x 194 x 155 (2.13 x 7.64 x 6.10)
Weight (incl. packaging and documentation)	1050 g (37 oz)

Analog inputs

Number	8	Each channel has its own ADC
Resolution	14 Bit	
Input level / type	ICP Sensor input +/-5 V, with 3mA current loop	Max. length of sensor cable 30 m
Dig. Low pass filter	6-pole, 72 dB	Low-pass corner frequency from 0.5 Hz to 12.5 kHz, set by software
High pass input characteristic	0.5 Hz / 6 dB 0.1 Hz / 6 dB on request	Due to the ICP measuring principle DC measurement is impossible
Programmable input gain	0..60 dB	In steps of 0.5 dB
Dynamic range SNR	84 - 140 dB	
Galvanic Isolation	Channel / Dev.-ground	1.5 kV

Binary inputs

Number	8	
Input level	log 0; < +/-6 V log 1; > +/-8 V	
Sampling	Simultaneously sampled with analog inputs	max. 25 kHz /channel
Galvanic isolation	Channel/Channel/Digital Ground	1.5 kV

12 Support and contact

Support

Phone: +49 911 97282-14
Fax: +49 911 97282-33
E-Mail: support@iba-ag.com



Note

If you require support, specify the serial number (iba-S/N) of the product.

Contact

Headquarters

iba AG
Koenigswarterstr. 44
90762 Fuerth
Germany
Phone: +49 911 97282-0
Fax: +49 911 97282-33
Email: iba@iba-ag.com
Contact: Mr. Harald Opel

Regional and Worldwide

For contact data of your regional iba office or representative please refer to our web site

www.iba-ag.com.