

Customized Monitoring - Allen-Bradley Controller Interfaces

ibaPDA Connectivity

Allen-Bradley

ControlLogix, FlexLogix
GuardLogix, CompactLogix
SoftLogix, MicroLogix

EtherNet/IP



ibaBM-ENetIP

Acquire data via EtherNet/IP



ibaPDA-Interface-EtherNet/IP

Acquire data via Ethernet



ibaPDA-Interface-Logix-Xplorer

Connection via Xplorer interface

ibaPDA Connectivity	
Acquire data from Allen-Bradley controllers	3
Acquire data via bus monitor	
ibaBM-ENetIP	5
Acquire data via Xplorer interface	
ibaPDA-Interface-Logix-Xplorer	5
Acquire data via data interface in ibaPDA	
ibaPDA-Interface-EtherNet/IP	6

Allen-Bradley Connectivity

The iba system offers several ways to acquire data from Allen-Bradley controllers, especially via EtherNet/IP – the right solution for different requirements.



EtherNet/IP

The Ethernet Industrial Protocol (EtherNet/IP) is an open standard for industrial networks. EtherNet/IP is used for the transmission of cyclic I/O data and acyclic parameter data. EtherNet/IP was co-developed by Rockwell Automation and is the established communication standard for Allen-Bradley controllers.

EtherNet/IP uses the application protocol CIP (Common Industrial Protocol) and the different communication types explicit messaging and implicit messaging.

Explicit messaging is used for data that is not transmitted in real time. Explicit messaging uses TCP.

Implicit messaging is often called "I/O", is time critical and is used for real-time data exchange. Implicit messaging uses UDP and supports multicast or unicast.

Connection to ibaPDA

The ibaPDA system offers various possibilities to acquire data from controllers via EtherNet/IP. Which method is best depends on, amongst other things, how quickly the data needs to be acquired, whether scan-cycle-synchronous data transmission is required and which hardware is available.

At a glance

- › Connection to Allen-Bradley controllers from Rockwell Automation via various interfaces: ibaBM-ENetIP, ibaPDA-Interface-EtherNet/IP, ibaPDA-Interface-Logix-Xplorer
- › Scan-cycle-precise acquisition via EtherNet/IP with bus monitor ibaBM-ENetIP
- › Connection without additional hardware with software interfaces ibaPDA-Interface-EtherNet/IP and ibaPDA-Interface-Logix-Xplorer
- › Free symbol selection with Xplorer interface
- › Simple, cost-effective connection via Xplorer interface

In addition, the Xplorer interfaces offer the option of selecting signals via a symbol browser without programming effort.

ibaPDA can run on a PC or on the stand-alone devices ibaDAQ-C and ibaDAQ. The two compact devices differ in their interfaces and the activated software licenses, see order information, page 7.

Sniffing with the bus monitor

If data needs to be acquired quickly and precisely with each scan cycle, the controller can be connected with the ibaBM-ENetIP bus monitor. The bus monitor acquires the cyclical data exchange between EtherNet/IP scanners and adapters. The device can be integrated into an existing EtherNet/IP network with one or

more EtherNet/IP scanners. The ibaBM-ENetIP bus monitor can be operated with the TAP interface in an EtherNet/IP network without interferences.

Connection via EtherNet/IP interface

The communication interface ibaPDA-Interface-EtherNet/IP offers different modules in ibaPDA to acquire data from the controllers. Depending on the selected module, ibaPDA acts as a device that passively waits for connections from a scanner or as a scanner that actively establishes the connections. The values to be recorded must be programmed in the controller and be sent by the controller program. Each change of values requires a program change.

The modules of the EtherNet/IP interface and their function:

- ▶ I/O Module
When using the I/O Module type, ibaPDA acts like an I/O adapter or device. The PLC controller is a scanner. Only implicit messaging is used. ibaPDA passively waits for a connection established by the PLC and the data being sent.
- ▶ Produced Tags
When using the Produced Tag type, ibaPDA acts like a tag consumer, the PLC controller as tag producer. ibaPDA enables the readout and adoption of the configuration of the available "produced tags". The data are then sent by implicit messaging.
- ▶ I/O Scanner
When using the I/O Scanner type, ibaPDA acts like a scanner and establishes the connection to a device. Such devices are usually remote I/O units or measurement devices. The data from the device are then sent by implicit messaging.

Signal selection without programming

Using special iba solutions, programming effort can be avoided: With the Xplorer interface the measured values can be freely selected via an address book by mouse click. In addition, the values to be measured can be changed without intervention in the programming while the controller is running.

How does the Xplorer interface work?

With Logix-Xplorer interface, it is possible to easily and cost-effectively connect to Allen-Bradley systems. The Xplorer interface allows free access to the internal data of a controller. The standard connections of each controller are used, additional hardware is not required. The measured values are cyclically requested and sent by the controller in a „polling“ procedure. Data acquisition is not scan-cycle-precise since the data is only sent by the controller when the request can be processed.

Different Xplorer interfaces

The Logix-Xplorer interface can be used to acquire data from the ControlLogix, GuardLogix, CompactLogix, SoftLogix and FlexLogix controllers.

MicroLogix controllers are supported by the interface ibaPDA-Interface-AB-Xplorer.

In addition, further Xplorer interfaces are available for many control systems: for SIMATIC, ABB, B&R, Bachmann M1, CODESYS-V2 und V3, Mitsubishi MELSEC, OMRON, SIGMATEK and Beckhoff TwinCAT controllers.



The mentioned Xplorer interfaces are available in a bundle for ibaPDA, but can also be licensed individually.

The bundle is also available as a cost-effective entry-level solution that is ideal, for example, for efficient troubleshooting during commissioning: ibaPDA-PLC-Xplorer offers the full ibaPDA functionality for up to 64 signals.

Detailed information on the Xplorer licenses can be found under order information on page 7.

Fields of application of the various interfaces



Requirement	iba interface	Example
<ul style="list-style-type: none"> ▶ Very short cycles ▶ Cycle precise 	ibaBM-ENetIP  ibaPDA-Interface-EtherNet/IP 	<ul style="list-style-type: none"> ▶ Fast control, e.g. gap control, rollforce etc. ▶ Complex logic (accuracy of cycle)
<ul style="list-style-type: none"> ▶ Longer cycles ▶ Nearly cycle precise 	ibaPDA-Interface-Logix-Xplorer 	<ul style="list-style-type: none"> ▶ Control of thermal processes ▶ Media control ▶ „Quick glance“ on a PLC



Acquire data with the bus monitor

The connection is established with the ibaBM-ENetIP bus monitor. This enables a fast and (bus) scan-cycle-precise acquisition of measured values.

ibaBM-ENetIP as sniffer

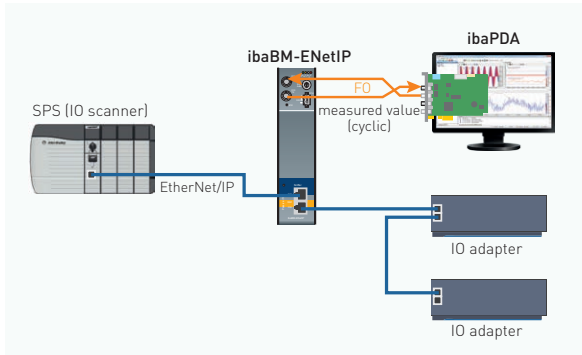

- › (Bus) scan-cycle-precise transmission of measured values
- › No programming and therefore no cycle load on the controller
- › Only existing data exchange between controller and IO adapter can be acquired
- › Analog values are transmitted as a raw value; signal selection requires knowledge of the structure of the transmitted data
- › CIP implicit messaging acquisition only

iba software	iba hardware
ibaPDA	ibaBM-ENetIP ibaFOB-D card (in the PC)

Logix-Xplorer

Acquire data via Xplorer interface

For data acquisition with the Xplorer interface the software interface Logix-Xplorer in ibaPDA is required or the bundle ibaPDA-PLC-Xplorer. Additional hardware is not necessary.

ibaPDA-Interface-Logix-Xplorer

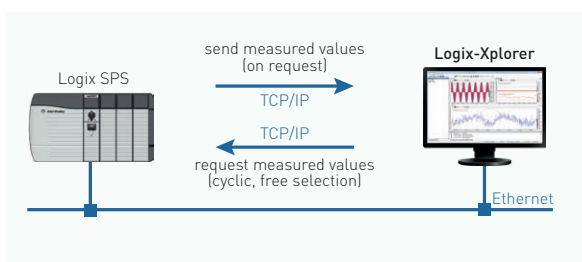

- › Simple configuration
- › No PLC program changes needed for selecting the values to be measured (free selection)
- › Possible to change the signal selection during operation
- › Access possible via TCP/IP
- › Support of CIP routing (via ControlNet / DeviceNet)
- › Use of CIP explicit messaging

iba software	iba hardware
ibaPDA and ibaPDA-Interface-Logix-Xplorer or ibaPDA-PLC-Xplorer (max. 64 signals)	-

MicroLogix controllers and legacy products such as PLC 5 or SLC 500 can be connected via the ibaPDA-Interface-AB-Xplorer interface.

Acquire data via EtherNet/IP interface

The connection is realized with the interface ibaPDA-Interface-EtherNet/IP in ibaPDA with different modules. The transmission performance depends on the network.

EtherNet/IP interface - I/O Module

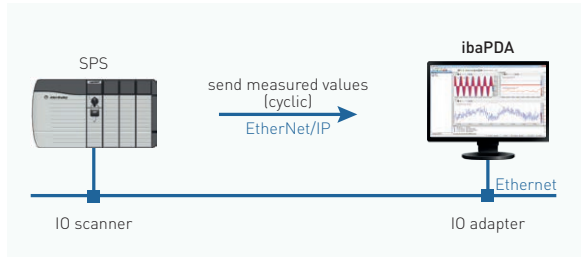

- › Low additional load of the CPU
- › PLC program must be changed for selecting the values to be measured
- › Transmission performance and quality depend on the network
- › Multiple adapter instances are supported in ibaPDA (need different IP addresses)
- › Support of unicast and multicast messages
- › Writing data to PLC supported (ibaPDA outputs)
- › Use of CIP implicit messaging

iba software	iba hardware
ibaPDA	-
ibaPDA-Interface-EtherNet/IP	

EtherNet/IP interface - I/O Scanner

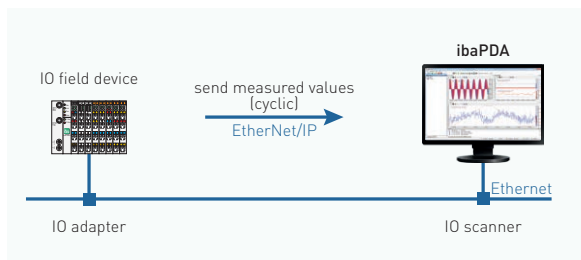

- › Direct connection of field devices without PLC
- › Transmission performance and quality depend on the network
- › Support of unicast and multicast messages
- › Writing data to the field device supported (PDA outputs)
- › Use of CIP implicit messaging

iba software	iba hardware
ibaPDA	
ibaPDA-Interface-EtherNet/IP	

EtherNet/IP interface - Produced tags

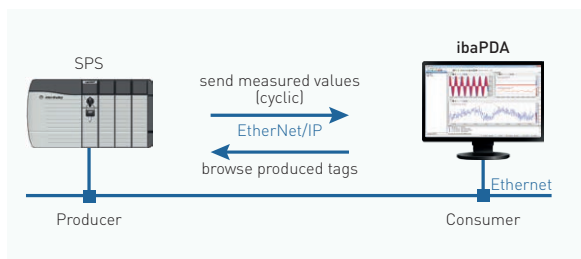

- › Low additional load of the CPU
- › PLC program must be changed for selecting the values to be measured (configuration of „produced tags“)
- › Transmission performance and quality depend on the network
- › Support of browsing produced tags
- › Support of CIP routing (via ControlNet / DeviceNet)
- › Support of unicast messages
- › Use of CIP implicit messaging

iba software	iba hardware
ibaPDA	
ibaPDA-Interface-EtherNet/IP	

Order information

Software

Order no.	Name	Description
30.770256	ibaPDA-256 ¹	Basic package for 256 signals, 2 clients, 2 data stores
30.681502	ibaPDA-PLC-Xplorer	ibaPDA system for 64 signals, 2 clients, 2 data stores + S7-Xplorer (interface for SIMATIC S7) + AB-Xplorer (interface for Allen-Bradley) + ABB-Xplorer (interface for ABB systems) + B&R-Xplorer (interface for B&R systems) + Bachmann-Xplorer (interface for Bachmann M1 systems) + Codesys-Xplorer (interface for CODESYS-based systems) + Logix-Xplorer (interface for ControlLogix systems) + MELSEC-Xplorer (interface for Mitsubishi MELSEC systems) + OMRON-Xplorer (interface for OMRON systems) + Sigmatek-Xplorer (interface to SIGMATEK systems) + TwinCAT-Xplorer (interface to Beckhoff systems) (up to 16 connections per interface)
30.770009	Upgrade-PLC-Xplorer to PDA-64	Upgrade to ibaPDA with 64 signals and PLC-Xplorer interfaces
31.001042	ibaPDA-Interface-PLC-Xplorer	License bundle of all current PLC-Xplorer interfaces for an ibaPDA system (up to 16 connections per interface)
31.000007	ibaPDA-Interface-Logix-Xplorer	License extension for ibaPDA system with a Logix-Xplorer interface (up to 16 connections)
31.100007	one-step-up-Interface-Logix-Xplorer	License extension for 16 more Logix-Xplorer connections
31.000003	ibaPDA-Interface-AB-Xplorer	License extension for ibaPDA system with an AB-Xplorer interface (up to 16 connections)
31.100003	one-step-up-Interface-AB-Xplorer	License extension for 16 more AB-Xplorer connections
31.001005	ibaPDA-Interface-EtherNet/IP	License extension for ibaPDA system with an EtherNet/IP interface (up to 64 connections)
31.101005	one-step-up-Interface-EtherNet/IP	License extension for existing interface for 64 more EtherNet/IP connections

¹ Other licenses are available for ibaPDA for a larger number of signals, clients and data stores.

Hardware

10.170001	ibaDAQ	Central unit for stand-alone data acquisition (incl. 2 Ethernet interfaces, 1 FO connection, ibaPDA-64)
10.170002	ibaDAQ-C	Compact device for stand-alone data acquisition (incl. 2 Ethernet interfaces, ibaPDA-64, ibaPDA-Interface-PLC-Xplorer, ibaPDA-OPC-UA-Server+, ibaPDA-Data-Store-MindSphere-16, ibaPDA-Interface-MQTT, ibaPDA-Data-Store-MQTT-16)
13.120010	ibaBM-ENetIP	Bus monitor for EtherNet/IP
11.118030	ibaFOB-2i-Dexp	FO card, PCI Express, 2 inputs
11.118020	ibaFOB-io-Dexp	FO card, PCI Express, 1 input, 1 output
11.118010	ibaFOB-2io-Dexp	FO card, PCI Express, 2 inputs, 2 outputs
11.118000	ibaFOB-4i-Dexp	FO card, PCI Express, 4 inputs
11.116200	ibaFOB-4o-D rackline-slot	FO card, 4 outputs, short design for ibaRackline
11.117010	ibaFOB-io-USB	FO adapter with USB interface, 1 input, 1 output



Headquarters Germany

iba AG

Office address

Koenigswarterstr. 44
D-90762 Fuerth

Mailing address

P.O. box 1828
D-90708 Fuerth
Tel.: +49 (911) 97282-0
Fax: +49 (911) 97282-33

www.iba-ag.com
info@iba-ag.com

Europe

iba Austria GmbH

Austria & Hungary
order@iba-austria.at

iba Benelux BV

Belgium, the Netherlands, Luxembourg,
France, Ireland, Great Britain,
French-speaking Switzerland
sales@iba-benelux.com

iba Czechia

Czechia, Slovakia
josef.dusek@compas.cz

iba Ibérica

Spain, Portugal
sales@iba-iberica.com

iba Italia S.R.L.

Italy, Slovenia, Croatia, Serbia,
Italian-speaking Switzerland
sales@iba-italia.com

iba Nordic

Denmark, Finland, Norway, Sweden
c/o Begner Agenturer AB
info@begner.com

iba Polska

c/o ADEGIS Sp. z o.o. Sp.k.
support@iba-polska.com

000 iba Russia

dmitry.rubanov@iba-russia.com

Asia

iba Asia GmbH & Co. KG

Western and Central Asia, Philippines,
Cambodia, Laos, Myanmar, Bhutan, Nepal
henry.regn@iba-asia.com

iba China Ltd.

julia.wang@iba-china.com

iba Gulf

Saudi Arabia, UAE, Qatar,
Kuwait, Bahrain and Oman
c/o ASM
a.magboul@iba-gulf.com

iba Indonesia

c/o PT. Indahjaya Ekaperkasa
sandhi.sugiarto@iba-indonesia.com

iba Korea System Co. Ltd.

Japan
hj.park@ibakorea.co.kr

iba Korea System Co. Ltd.

Korea
sh.lee@ibakorea.co.kr

iba Malaysia

c/o iba Engineering & Consulting
(Malaysia) SDN. BHD
bruno.marot@iba-malaysia.com

iba Singapore

c/o iba (S.E.A.) Engineering &
Consulting Pte. Ltd.
bruno.marot@iba-sea.com

iba Systems India Pvt. Ltd.

India, Bangladesh, Nepal, Pakistan, Sri Lanka
shraddhap@iba-india.com

iba Thailand

c/o SOLCO Siam Co. Ltd.
pairote@iba-thai.com

iba Turkey Ltd.

ahmet@iba-turkey.com

iba Vietnam

c/o Tang Minh Phat Co., Ltd
sales@iba-vietnam.com

Australia and Oceania

iba Oceania Systems Pty Ltd.

Australia, New Zealand, PNG, Micronesia and
South Pacific Islands (except US territories)
fritz.woller@iba-oceania.com

Central and South America

iba LAT, S.A.

eric.di.luzio@iba-lat.com

iba LAT Argentina

alejandro.gonzalez@iba-lat.com

iba LAT Bolivia

mario.mendizabal@iba-lat.com

iba Brasil

iba@iba-brasil.com

iba Chile

iba@iba-chile.com

North America (USMCA)

iba America, LLC

USA
esnyder@iba-america.com

iba America, LLC

Canada
dkober@iba-america.com

iba America, LLC

Mexico
jgiraldo@iba-america.com

Africa

iba Benelux BV

Maghreb (Morocco, Algeria, Tunisia), Senegal
sales@iba-benelux.com

iba Africa

South Africa
c/o Variable Speed Systems cc
danie@iba-africa.com

iba AG is represented worldwide by
subsidiaries and sales partners.
Technical changes and errors excepted.