

ibaF0B-2io-X

PCI Interface Board with High Data Transmission Rate

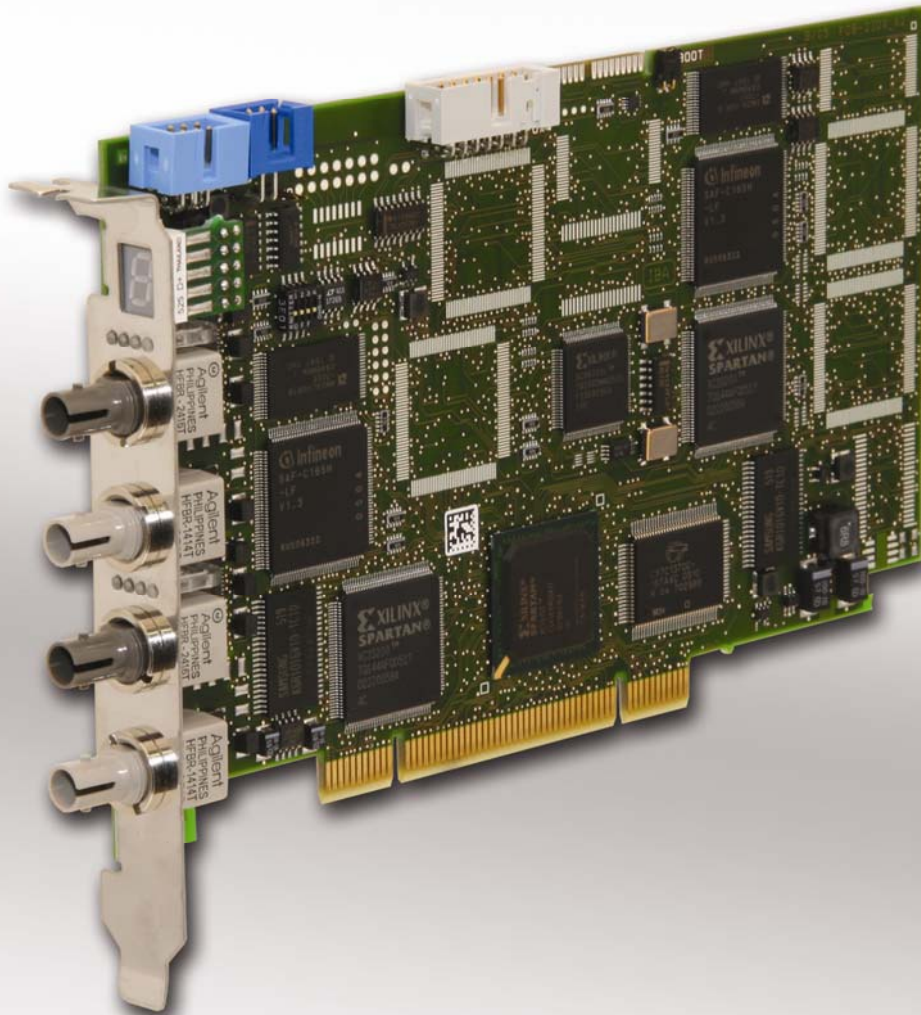

Manual

Issue 1.8

Measurement and Automation Systems



ibaFOB-2io-X -Manual

Issued by

iba AG
 Koenigswarterstr. 44
 90762 Fuerth, Germany

Tel.: + 49 (0)911 9 72 82-0

Sales -27

Support -14

R&D -13

FAX -33

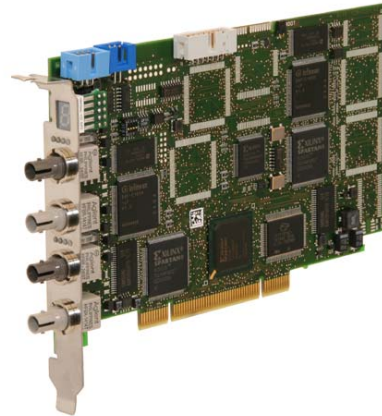
Email: iba@iba-ag.comWeb: www.iba-ag.com

Unless explicitly stated to the contrary, it is not permitted to pass on or copy this document, nor to make use of its contents or disclose its contents. Any violation is treated as an act liable for damages.

© iba AG 2009 all rights reserved.

ibaFOB-2io-X - Manual V 1.5 en / ibaFOB A2/A1

We have checked that the contents of this manual match the hardware and software described here. However, deviations cannot be fully ruled out, so that we cannot assume any warranty should any deviations actually exist. This manual is regularly updated. Necessary revisions are included in future editions, or can be downloaded from the Internet.

The latest version is always available for downloading at:

<http://www.iba-ag.com>

We would welcome any suggestions for improvements which you may have.

Version	Date	Revision	Chapter / pages	Author	Version HW/FW
V 1.8	03/02/12	Chapter Accessories removed		st	

Contents

<u>5</u>	<u>This manual</u>	<u>5</u>
<u>1</u>	<u>Introduction</u>	<u>6</u>
1.1	The ibaFOB I/O Concept.....	6
1.2	What's new?.....	7
<u>2</u>	<u>Scope of Delivery</u>	<u>8</u>
<u>3</u>	<u>Safety Information</u>	<u>8</u>
<u>4</u>	<u>Installation / Uninstallation</u>	<u>9</u>
4.1	Preparation.....	9
4.2	Installing the Card	10
4.3	Removing the Card	10
<u>5</u>	<u>System Requirements</u>	<u>11</u>
5.1	Hardware.....	11
5.2	Software	11
<u>6</u>	<u>System Integration</u>	<u>12</u>
6.1	Sample Topologies with ibaFOB-2io-X	12
6.1.1.	Operation for data acquisition	12
6.1.2.	Operation with ibaLogic (Soft-PLC).....	12
6.1.3.	Operation with ibaLogic (Vibration Monitoring, Bearing Monitoring)	13
6.1.4.	Operation with ibaPDA-V6 in X-Mode.....	13
<u>7</u>	<u>Device Description</u>	<u>15</u>
7.1	Device Properties	15
7.2	Views, Displays and Connectors	16
7.3	Front Side Elements.....	17
7.3.1.	Status-LEDs	17
7.3.2.	7-Segment Display.....	17
7.3.3.	Fiber Optic Interface of ibaFOB-2io-X.....	17
7.4	Expansion Modules	18
7.4.1.	Combinations with ibaFOB-2io-X.....	18
7.4.2.	Fiber Optic Interfaces of ibaFOB-4o-X (optional).....	19
<u>8</u>	<u>Configuration and Engineering</u>	<u>20</u>
8.1	Configuration and Diagnostics with ibaPDA-V6.....	20
8.1.1.	Configuration of the Card.....	20
8.1.2.	Module and Signal Configuration (F-Mode)	23
8.1.3.	Module and Signal Configuration (X-Mode).....	24
8.1.4.	Diagnosis	28
<u>9</u>	<u>Synchronization of Several Boards</u>	<u>29</u>
<u>10</u>	<u>Technical Data</u>	<u>30</u>
<u>11</u>	<u>Support and Contact</u>	<u>31</u>

This manual

This compact manual provides the information for installation and handling of the device ibaFOB-2io-X.

For further information concerning the system integration and software configuration please refer to the corresponding engineering manuals and / or software documentation of our software products used in conjunction with this device.

You can find the latest issue of this manual always on our website <http://www.iba-g.com> in the download area.

This manual uses several symbols which essentially have the following meanings:



Important hint or warning in order to avoid hazard against material or life.



A useful tip or clue to make your work easier.



This draws your attention to special features, such as exceptions to rules, etc.



A reference to additional documentation or more in-depth literature.



iba training courses

Hint for training courses by iba concerning related products or subjects

Copyright notice

Windows is a registered trademark of Microsoft Corporation.

Other product or company names mentioned in this manual may be brand names or registered trademarks of the corresponding owner.

1 Introduction

The board ibaFOB-2io-X is a fiber optic communication card like the other well-known boards ibaFOB-io-PCI, ibaFOB-io-S, ibaFOB-4i-PCI, ibaFOB-4i-S, ibaFOB-4o and ibaFOB-OF-Link which are used to connect a standard PC to the iba peripheral devices such as ibaPADUs, ibaNet750 devices and ibaLink signal modules (SM).

The essential difference to the boards without the "X" in the name is a higher data transmission rate on the fiber optic link. Of course, in order to take advantage of this enhanced data rate there should be the appropriate peripheral devices installed which support the high data rate too. On one hand these are devices from iba which carry the "X" in the name and on the other hand system components of other manufacturers like ABB AC 800 PEC or Simatic TDC with LO5A interface.

As far as the following text does not refer to a particular card, the boards are referred to as ibaFOB boards.

1.1 The ibaFOB I/O Concept

The unique peripheral I/O concept based on the ibaFOB boards, features characteristics otherwise unknown on standardized field buses such as:

- Full deterministic transmission profiles for all fiber optic buses and connected devices (1 ms).
- Internal and/or external synchronization on the bus, even for more than one bus with programmable cycle times between 1.0 and 9.9 ms in steps of 100 μ s.
- Deviation less than 2 μ s between several buses (external synchronization)
- The iba fiber optic transmission standard integrates not only A/D converters (ibaPADU) but a huge variety of PLC interfaces and hence allows the realization of heterogeneous measuring and I/O topologies. The following devices can be connected:
 - ibaFOB cards incl. ibaFOB x/4-F (ISA) and ibaFOB-OF-Link
 - ibaLink-SM-64-io (Siemens Simatic S5 115U, 135U 155U; MMC216 all types)
 - ibaLink-SM-128V-i-2o (VME32 & VME64 rack)
 - ibaNet750 (Wago IO system 750)
 - ibaBM-FOX-i-3o (FO-splitter and repeater)
 - ibaPADU-8, ibaPADU-8-ICP, ibaPADU-8-M, ibaPDAU-8-S, ibaPADU-16, ibaPADU-16-M-2, ibaPADU-32-T, ibaPADU-32-R and ibaPADU-8-O
 - ibaBM-SLM (Simolink Monitor for Siemens Motion Link Bus)
 - ibaBM-DDCSM (Monitor for ABB DDCS+ Drivebus)
- Adjustable bus timing (ring topology in combination with ibaLogic only!)
- Easy handling without the termination problems of copper based systems
- The integration in hazardous areas is no problem in terms of EMI due to the fiber optic communication concept.
- One source can be accessed by multiple clients at the same time by just multiplying the optical fibers (ibaBM-FOX-i-3o and ibaFOB-OF-Link splitting devices) – so I/O peripherals may be used for process control and measuring at the same time. This also makes redundant structures easy.

1.2 What's new?

The ibaFOB-2io-X and respectively the ibaFOB-4i-X and ibaFOB-2i-X card represent the new generation of iba's fiber optic PC boards. These boards extend the existing board family and will replace the previous ibaFOB-cards in long-term. The new boards are 100% compatible on the fiber optical bus side while in the PC the interface and dual port ram layout differ between the old and new boards.

The new cards features are:

- ❑ Full Plug&Play functionality.
- ❑ Three different data transmission rates per optical link:
3.3 Mbit/s, 5 Mbit/s and 32 Mbit/s
The 2 MBit data transfer to the old ibaPADU-16, - 32 devices is not supported.
(All ibaPADU-16 and -32 with serial number 999 and below use 2 Mbit data transfer.)
- ❑ Three modes of operation on each fiber optic link:
 - F-mode, for data acquisition and output up to 1 kHz (1 ms cycle) with 3.3 Mbit/s
 - M-mode, for data acquisition up to 25 kHz (40 µs cycle) with 5 Mbit/s
 - X-mode, for data acquisition up to 20 kHz (50 µs cycle) with 32 Mbit/s
- ❑ Enhanced card diagnostics and card information in ibaPDA-V6

2 Scope of Delivery

The following components are included with the delivery.

- ibaFOB-2io-X device
- Flat ribbon cable with four jacks for iba card interrupt synchronization
- Manual

3 Safety Information

Please consider the following safety advises:



W A R N I N G!

To avoid electrical shock during installation or uninstallation of the device disconnect the power supply from the computer before opening.



CAUTION!

This board contains components which can be destroyed by electrostatic discharge. Prior to touching any electronics board, your body must be electrically discharged. This can be simply done by touching a conductive, grounded object immediately beforehand (e.g. bare metal cabinet components, socket protective conductor contact).

4 Installation / Uninstallation

4.1 Preparation

The card fits in every compatible PCI slot.



CAUTION!

Use a ground line or discharge any electrostatic charge from yourself before touching the card.



The standards for handling electrostatic sensitive devices (ESD) must be followed.



Note

Please follow carefully the advises below. Not to do so may void your warranty.

- Remove and install cards only in a ESD designated workspace.
- Remove all power connections from the PC before opening the PC and/or installing/removing any device.
- Never remove or (un-)solder chips or other parts of the device because this may damage the device and void your warranty.

4.2 Installing the Card

- 1 Switch off the PC, disconnect it from power supply and open it, so that you can see the PCI slots.
- 2 Unpack the card carefully. Use a ground line or discharge any electrostatic charge from yourself before touching the card.
- 3 No settings of jumpers or switches are required.
- 4 Take hold of the card on the board edges and the front panel.
- 5 Press the card carefully into the desired PCI connector of the main board. Check that the card is fully plugged into the slot and fix the card with the screw on the front panel.
- 6 If more than one iba-card are used connect all iba cards with the synchronization cable.
- 7 Close the computer, connect the power supply and start it.

4.3 Removing the Card

In order to remove the card from the PC please follow these steps:

- 1 Stop and switch off the computer, disconnect it from the power supply and open it.
- 2 Release the screw in the front panel.
- 3 Pull out the card off the PCI slot carefully and put in a safe place or conductive plastic bag.

5 System Requirements

5.1 Hardware

IBM-compatible PC with the following minimum configuration:

- 2 GHz Pentium IV or better ¹⁾
- 512 MB RAM or better ¹⁾
- At least one free PCI slot per card

Please see <http://www.iba-ag.com> for further details on a properly outfitted workstation.

¹⁾ Recommendation for operation of two ibaFOB-4i-X (= 8 FO-links) with 32 Mbit/s. Lower requirements, lower transmission rates or less links permit use of PCs with lower performance.

5.2 Software

- Microsoft Windows 2000, XP or 2003 Server
- ibaPDA Version V 6.5.2 or higher
- ibaLogic 3.88 p

6 System Integration

6.1 Sample Topologies with ibaFOB-2io-X

6.1.1. Operation for data acquisition

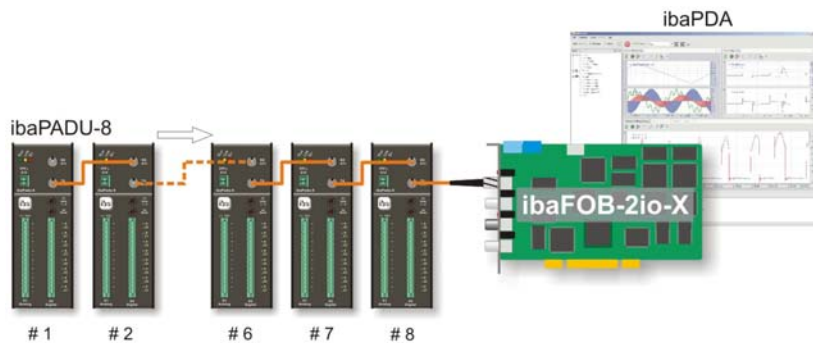

Peripheral devices

all ibaPADU except ibaPADU-8-ICP and -8-M,
 ibaDig-40, ibaBM-DDCSM, ibaBM-SLM, ibaBM-DPM64
 ibaLink-SM-64-io, ibaLink-SM-64-SD16, ibaLink-SM-128V-i-2o,
 ibaLink-MBII-io

Mode of operation

F-Mode

Transmission rate (FO)

3.3 MBit/s (input)

Sample rate

1 Hz ... 1 kHz

Sample time

1000 ms ... 1 ms

Applications

ibaPDA-V6
 ibaQDR-V6
 ibaLogic

6.1.2. Operation with ibaLogic (Soft-PLC)

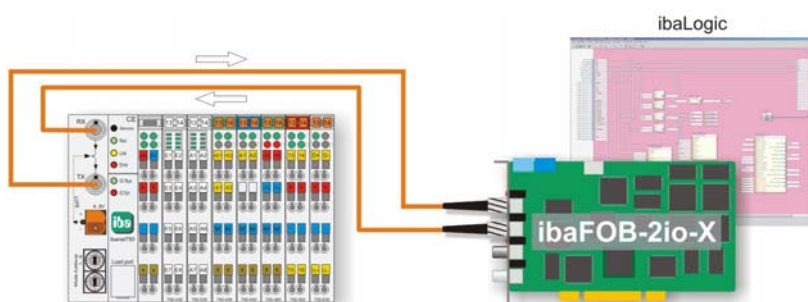

Peripheral devices

all ibaPADU except ibaPADU-8-ICP and -8-M, ibaDig-40,
 ibaNet750-BM, ibaBM-DDCSM, ibaBM-SLM, ibaBM-DPM64
 ibaLink-SM-64-io, ibaLink-SM-64-SD16, ibaLink-SM-128V-i-2o,
 ibaLink-MBII-io

Mode of operation

F-Mode

Transmission rate (FO)

3.3 MBit/s (input)
 3.3 MBit/s (output)

Sample rate

1 Hz ... 1 kHz

Sample time

1000 ms ... 1 ms

Applications

ibaLogic
 ibaPDA-V6 (alarm output)

6.1.3. Operation with ibaLogic (Vibration Monitoring, Bearing Monitoring)

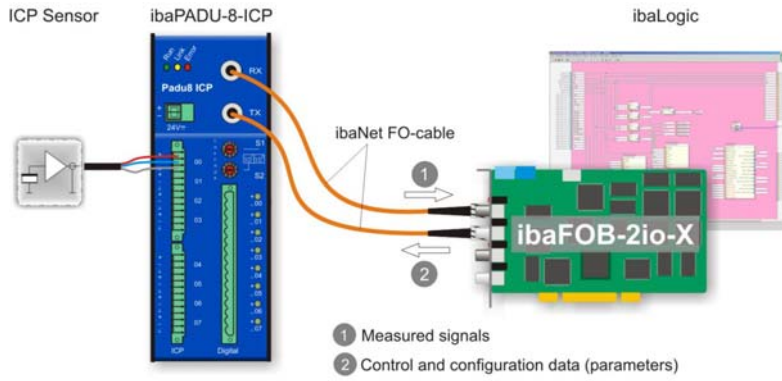

Mode of operation	M-Mode
Transmission rate (FO)	5 MBit/s (input) 5 MBit/s (output)
Sample rate	0.5 kHz ... 25 kHz
Sample time	2000 ms ... 40 µs
Applications	ibaLogic (Asynchronous mode)

Peripheral devices

ibaPADU-8-ICP, ibaPADU-8-M, ibaDig-40

6.1.4. Operation with ibaPDA-V6 in X-Mode

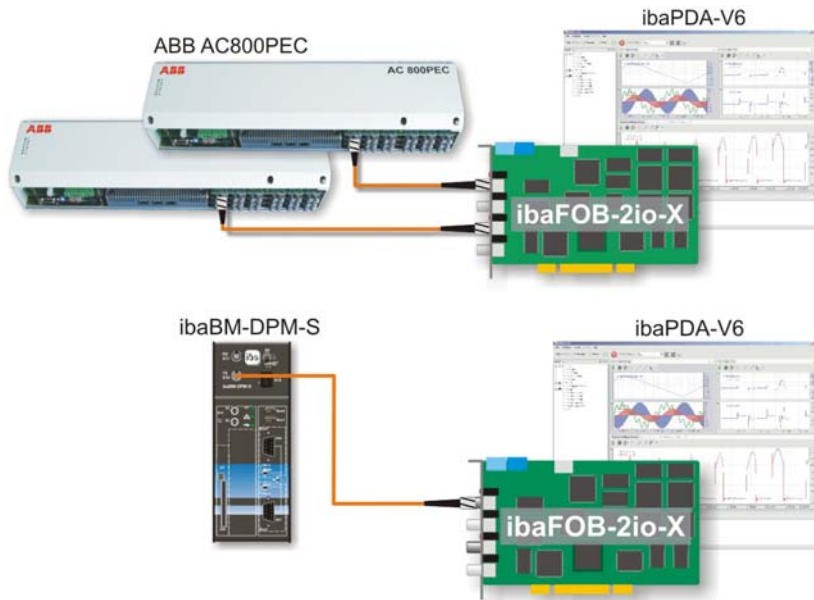

Mode of operation	X-Mode
Transmission rate (FO)	32 MBit/s
Sample rate	1.25 kHz ... 20 kHz
Sample time	800 µs ... 50 µs

Peripheral devices

ABB AC 800PEC with ibaNet-output module
 Simatic TDC with LO5A-interface board
 ibaLink-VME-2io-X (in preparation),
 ibaLink-MBII-2io-X (in preparation)
 ibaBM-DPM-S (PROFIBUS-Monitor)
 ibaBM-CAN (in preparation)

Applications	ibaPDA-V6
---------------------	-----------

The following table shows the permitted combinations of modes of operation and software applications:

Mode of operation	F-Mode		M-Mode		X-Mode	
Data transmission rate	3,3 MBit/s		5 MBit/s		32 MBit/s	
Sampling rate	1 Hz ...1 kHz		0.5 kHz ...25 kHz		1.25 kHz ... 20 kHz	
Number of signals per FO-link	64 A + 64 D		8A + 8D (768A+768D 96 devices in ring)		512 ... 16	
Application	Input	Output	Input	Output	Input	Output
ibaPDA-V6	■	■ ¹⁾	-	-	■	_2)
ibaLogic	■	■	■	■ ³⁾		
ibaScope	-	-	-	-	-	-

¹⁾ Alarm outputs, ²⁾ Alarm outputs with 3,3 MBit/s on another link,

³⁾ Only parameters to ibaPADU-8-M, -8-ICP, ibaDig-40 (Asynchron-Mode)

7 Device Description

7.1 Device Properties

- ❑ Full compliant PCI V2.2 board
- ❑ Two bi-directional (ibaFOB-2io-X) or four unidirectional (ibaFOB-4i-X) independent fiber optic channels
- ❑ Each optical link has its own microprocessor
- ❑ 256 kbyte per link
- ❑ Firmware upgrade in the PC without uninstalling the card
- ❑ Four LEDs for each input channel indicating CPU life counter (green), optical link status / data transmission rate (yellow, white) and processor error (red)
- ❑ 7-segment display for board-ID and indication of sync master board
- ❑ Expansion connector for ibaFOB-4o-X module to monitor the input and output data streams
- ❑ No jumpers or DIL switches, all parameters are software controlled (the switch on top of the board is for iba internal use only); interrupt synchronization cable to connect multiple iba cards in one PC
- ❑ Dynamic reassigning of interrupt sources and interrupt generation (board and driver synchronization)
- ❑ Dynamic assignment of bus cycle time in steps of 100 μ s (accuracy +/-400 ns). Minimum cycle is 1.0 ms; max cycle 9.9 ms (ring topology only!); default 1.0 ms
- ❑ Synchronous sampling on daisy chained devices on the fiber optic bus can differ with a maximum of -800 ns to + 1300 ns relative to device #1 channels (worst case measured with 1 ms basic sampling time); the fiber optics between devices should not exceed 1 m.

7.2 Views, Displays and Connectors

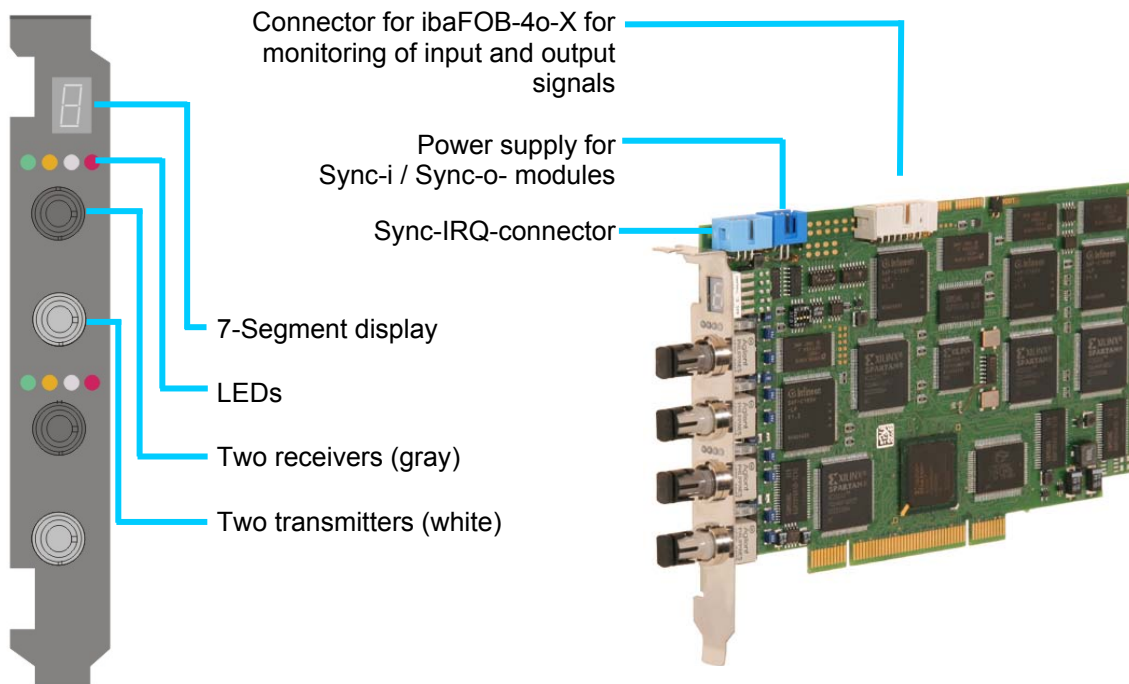

7.3 Front Side Elements

7.3.1. Status-LEDs

Run, Link and Error LEDs indicate the operational state of the ibaFOB channels. The following table describes the states in which you may find the LEDs and their respective meanings. When switching on power all LEDs are on for a few seconds to prove their proper function.

LED	Status	Description
Run (green)	Flashing	power is on and the channel is functioning properly
	OFF	controller stopped
Link (yellow)	ON	receiving / sending telegrams on this channel
	OFF	no telegrams received; fiber optics not connected or sending device off
Error (red)	ON	internal error in controller link
	OFF	normal state; after resolution of error, LED automatically resets
Rate (white)	ON	Transmission with 32 Mbit/s active (X-mode)
	Flashing	Set to X-mode but no telegrams received.
	OFF	Transmission with 3.3 Mbit/s (F-mode) or 5.0 Mbit/s (M-mode)

7.3.2. 7-Segment Display

The 7-segment display shows the following information

- Board-ID (ranging from 0...7) - after board was initialized; when board is not initialized a horizontal line is displayed.
- The decimal point in the display indicates whether the board is dedicated to be...
 - an internal interrupt master (dot is on) or
 - an external interrupt master (dot is blinking) or
 - an interrupt slave (dot is off).

7.3.3. Fiber Optic Interface of ibaFOB-2io-X

The ibaFOB-2io-X provides two pairs of ST type jacks - one optical sender (white) and one optical receiver (grey) each.



If the card was configured for external synchronization, e. g. for operation with an ibaBM-SLM, the input channel needs to be connected with the external device for proper function (otherwise the whole PC process will be stopped).

The external sync configuration channel will be indicated by a blinking point in the 7-segment display so that the correct data input can be identified easily (F-mode only).

7.4 Expansion Modules

7.4.1. Combinations with ibaFOB-2io-X

The following schematics show how the ibaFOB-2io-X board may be combined with the ibaFOB-4o-X module to achieve a full monitored process I/O system for 128 analog and 128 digital input and output channels.

To do this connect the ibaFOB-4o-X to the ibaFOB-2io-X by the white 20-pin connector. The ibaFOB-4o-X module mirrors the input and output signals.

Parallel (monitored) input and output signals

Input signals

max. 2 * (64 A + 64 D), F-mode, 3.3 Mbit/s

max. 2 * (8 A + 8 D), M-mode, 5.0 Mbit/s

(768 A + 768 D with 96 devices in ring)

max. 2 * 512, X-mode, 32 MBit/s

Output signals

max. 2 * (64 A + 64 D), F-mode, 3.3 Mbit/s

2 * parameters, M-mode, 5.0 Mbit/s

max. 2 * 512, X-mode, 32 Mbit/s (i. prep.)

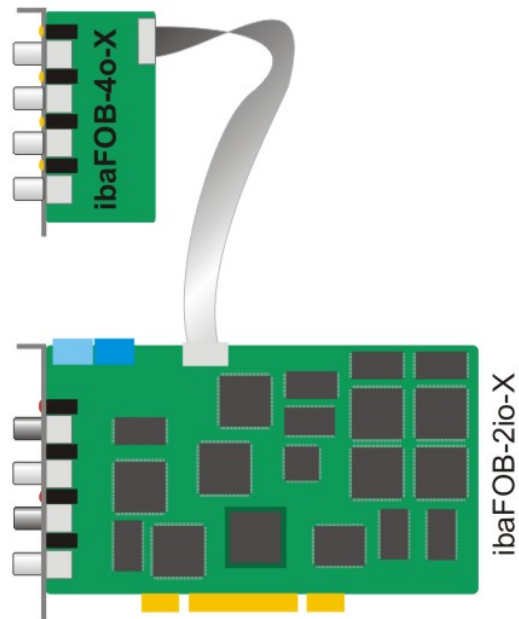

If the PC power supply is switched OFF, all "monitored signals" are off because the monitoring involves an optical – electrical – optical conversion - which cannot work without the PC's power supply.



The ibaFOB-2io-X card can monitor the input and the output signals by means of the ibaFOB-4o-X module. According to the order of FO-ports on the ibaFOB-2io-X the ibaFOB-4o-X will transmit two pairs of input and output signal sets.

7.4.2. Fiber Optic Interfaces of ibaFOB-4o-X (optional)

The ibaFOB-4o-X expansion module provides four optical transmitters (white ST jacks). Channel #1 is the upper channel.

The module provides both the full four-channel output function in terms of ibaLogic and the optical mirror function for monitoring input (and output) signals.

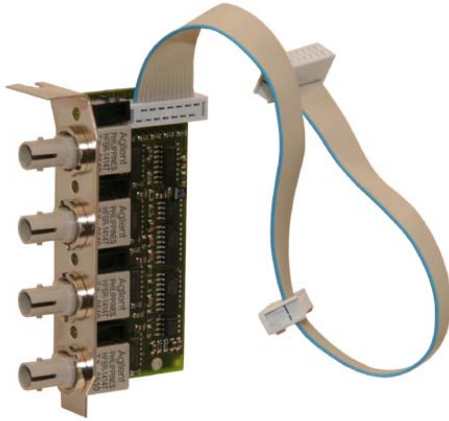

Beside the fiber optic ports, this module provides further connections to...

- ibaFOB-4i-X / ibaFOB-2io-X

Two different builds are available:

a) with short front plate (picture)

ibaRackline PCs have special slots in the housing for this kind of build. They enable installation of these modules without blocking regular PCI slots.

b) with long standard front plate

This kind may be installed on all standard slots in any PC. The opening in the housing will be blocked for other PC cards though the PCI connector is not used.

Using this module as an output module only makes sense in conjunction with an ibaFOB-4i-X board because only then you'll get four full bidirectional channels. The ibaFOB-2io-X – as the name says – already has two output channels on board.

If the module is used for mirror function then another iba system may be supplied with the same input signals, e. g. ibaPDA and ibaLogic. Therefore, connect the module with the white 20-pin connector on the ibaFOB-2io-X or ibaFOB-4i-X card.

8 Configuration and Engineering

8.1 Configuration and Diagnostics with ibaPDA-V6

The entire configuration is to be done in the I/O-manager of ibaPDA-V6. The board is managed as data interface of type FOBF-PCI.

The same interface type is used for ibaFOB-2io-X and ibaFOB-4i-X. The system automatically detects which type(s) of card(s) are installed in the PC and displays them in the signal tree.

8.1.1. Configuration of the Card

If an ibaFob-2io-X or ibaFob-4i-X card is installed, you'll find an additional tab *FOB* in the *General* dialog.

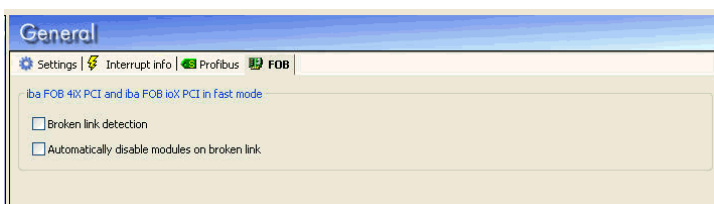

These settings apply to measurements with high data rate only. If you use the card in F-mode the settings are not relevant. These settings are used to control the behaviour of the card in case of communication errors.

Broken link detection

If you choose this option then all Fob-links will be monitored. If a connection is broken then the measurement is stopped and an error message will be posted in the event log.

Automatically disable modules on broken link

If you enable this option the system will check the links during validation of I/O configuration. If a link is detected as broken the related modules will be disabled. Then the I/O configuration validation will be finished and the measurement will be started.

If you mark the branches in the tree view you'll get the relevant information and you can make the required settings respectively.

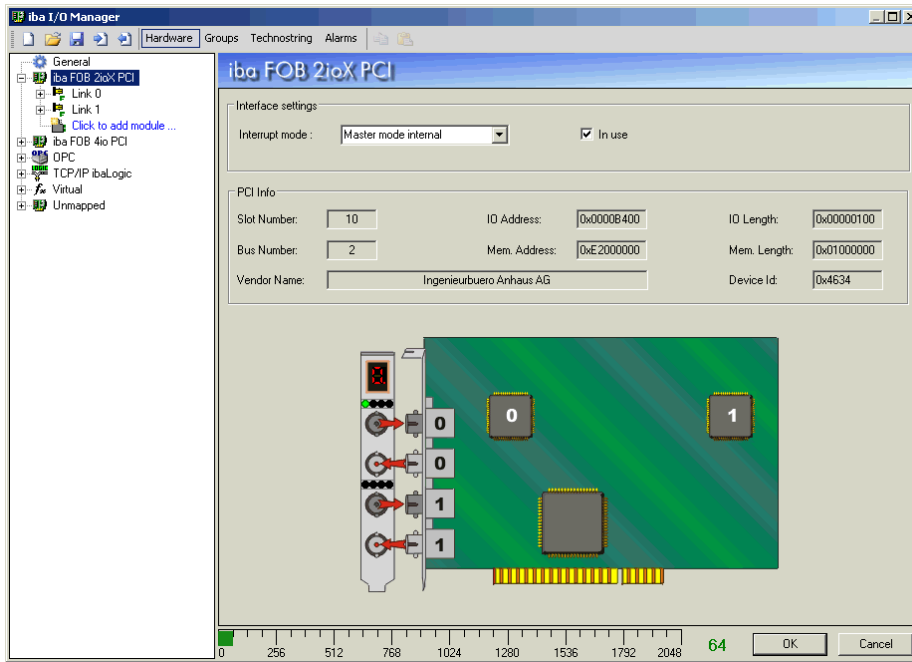

A mimic of the card is displayed in the dialog box when you mark the main branch of the card in the tree view.

At this point you should set the interrupt mode (master internal / master external / slave).

If you mark the sub branches with the links you'll get further information about the processors.

There are different sets of information, depending on whether a link is operating in X-mode or F-/M-mode.

a) Link operating in F-Mode (with ibaPADU-8)

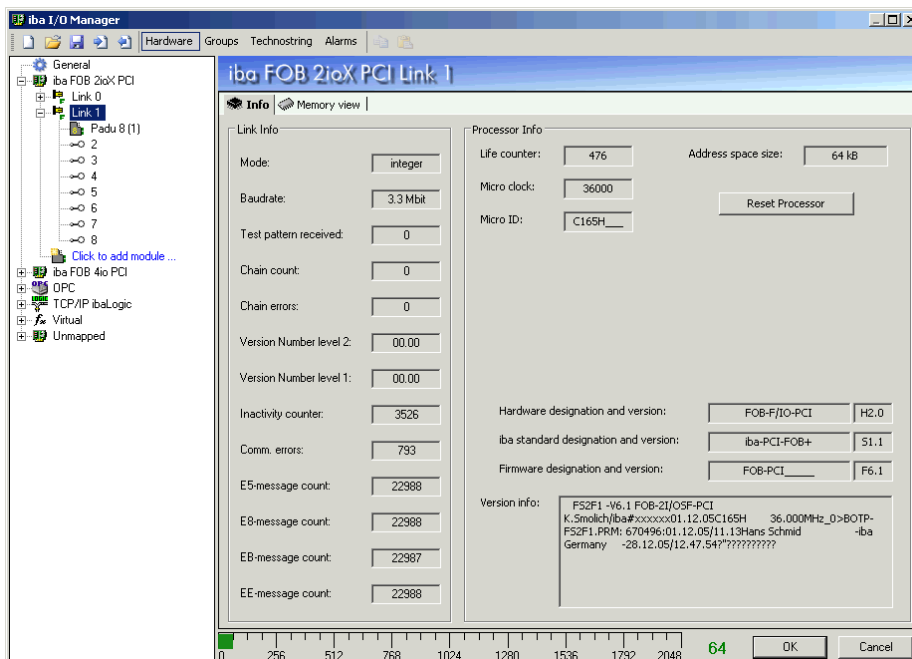

b) Link operating in X-mode (with FobFast module)

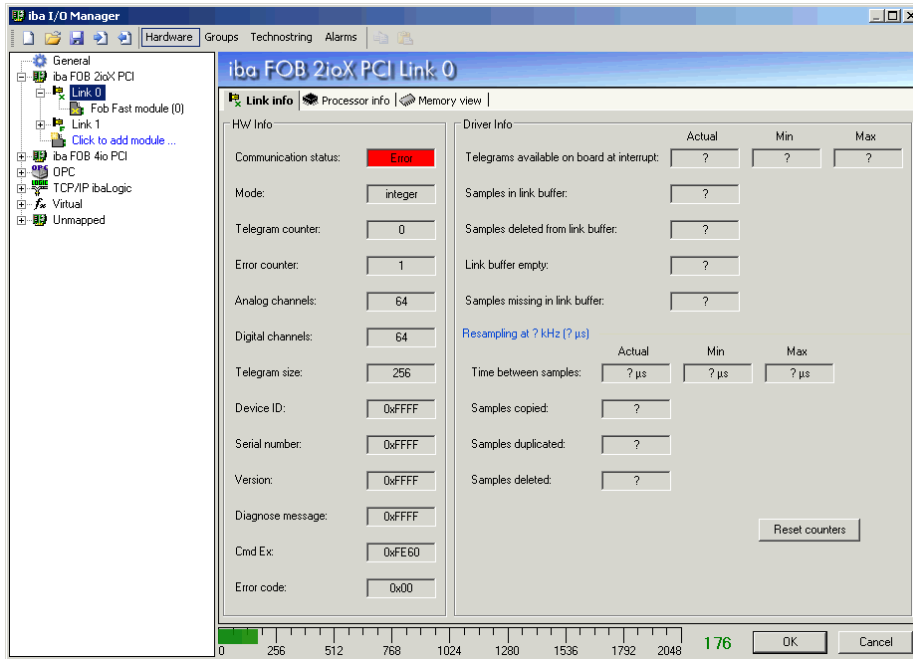

Due to the additional driver information the processor information has moved to another tab.

The driver information shows a status overview of the fast communication.

If you open the "link"-branches you can see the connected devices (= modules). Each link is subdivided in eight groups of eight channels each (64 in total per link) which corresponds to the smallest information package in the ibaPADU-8 philosophy.

8.1.2. Module and Signal Configuration (F-Mode)

In order to measure signals you should map the modules (i. e. the devices) to the links. Let's take an ibaPADU-8 for example.

If a connected and active ibaPADU-8 was not detected automatically you may add the device in the I/O manager in the tree view by a right mouse click on the desired link.

In order to configure the signals you should mark the module in the tree view.

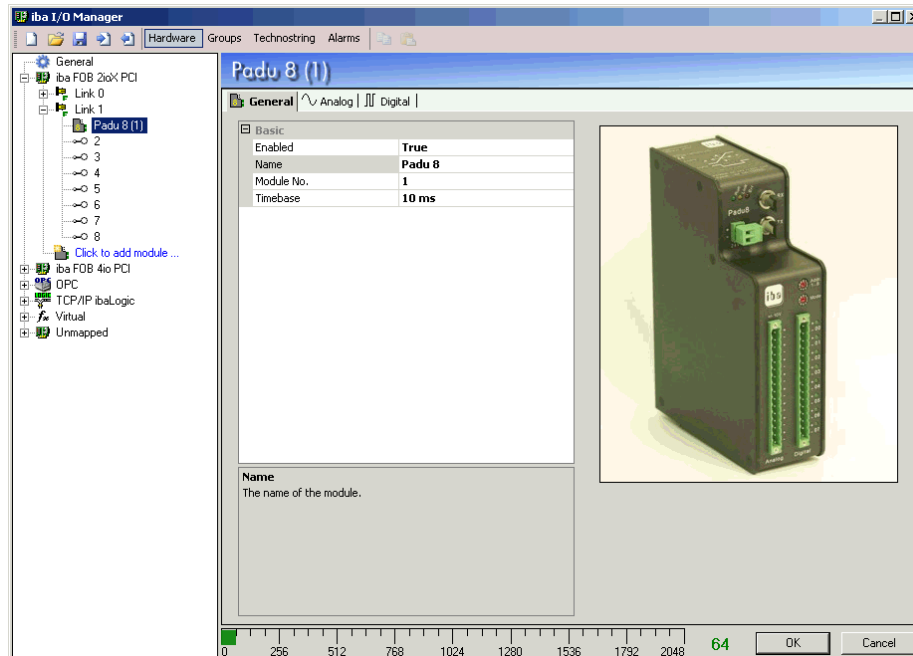

Click on the tab *General* in this dialog box and you can make the general settings for the module, such as module name, module number and sample time (if different from basic sample time).

Under the tabs *Analog* and *Digital* you can enter and configure the signals.

In the signal tables you can give a name to the signals assign physical units and limit values (Max, Min) or set the signals active or passive. The column *Actual* shows already incoming values when an active device is physically connected.



Further information finds you in the manual *ibaPDA-V6*.

8.1.3. Module and Signal Configuration (X-Mode)

If measurements are to be performed with the card operating in X-mode (32 Mbit/s) a so called FobFast module should be added to the corresponding link.

The module type is only available if an ibaFob-2io-X or ibaFob-4i-X card is installed.

Fob Fast modules can only be connected to links which are configured for high data rate mode.

The high data rate mode of a link is indicated by a little X at the symbol in the signal tree



FobFast-Module (X-Mode)	Peripheral device
Fob Fast module	ABB AC 800PEC
ibaBM-DPM-S	ibaBM-DPM-S

Add a FobFast module and make the general settings first.

8.1.3.1. FobFast Module – General Settings

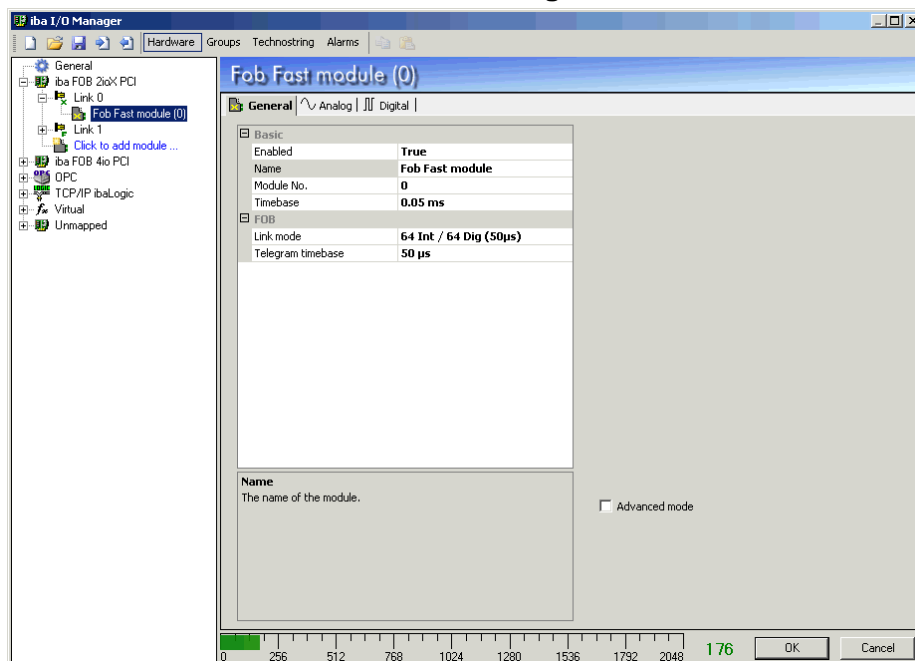

Enabled

With selection of one of the options in the drop-down list in the field next to *Enabled* you decide whether this module is to be enabled (True) or disabled (False). If a module is disabled then its signals are excluded from acquisition. Thus, they are not available neither for display nor for recording. Furthermore, the number of signals from a disabled module will not be taken into account in the signal statistics (signal-o-meter).

Name

In the field next to *Name* enter a comprehensive name for the module.

It is recommended to use an application-specific nomenclatura for a better clearness and comprehension, particularly with vast numbers of modules. The name may refer to a technological purpose or a special location in the plant, where the module is used or installed.

The number of characters in the name is unlimited. The name of the module is stored in the data file and visible in ibaAnalyzer.

□ **Module No.**

In the field next to *Module No.* you may enter a module number (= module index). When adding modules to the configuration the system gives numbers automatically in a chronological order. However, you may prefer a different order later in the data file for analysis. Feel free to change the module number according to your needs. The module number determines the order in the signal tree in ibaAnalyzer.

For the module type TCP/IP ibaLogic the module number must match the module index as configured in the ibaLogic application.

□ **Timebase**

In the field next to *Timebase* you may enter a time value, given in ms, which is an integer multiple of the general timebase as configured in the *General* branch of the I/O manager tree. All signals of the module will then be sampled on this timebase. The ratio between max. and min. timebase for all modules is limited to 1000. The timebase value is limited to 1000 ms.

With a Fob Fast module the timebase must be an integer multiple of the telegram timebase (see below).

□ **Link mode**

The link mode should be selected from the drop-down list in this field. A variety of modes or data types is available. Due to the limited capacity of the different components there is a relation between number of signals, data type and shortest time base. Furthermore, the link mode depends on the connected system which sends the data.

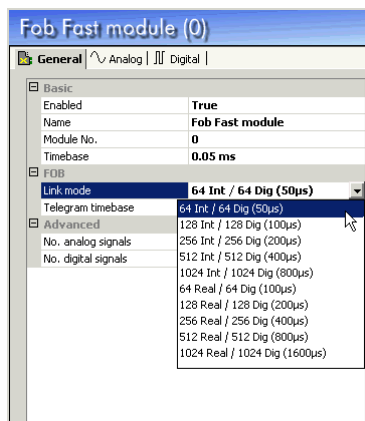

By selection of the link mode, i. e. data types, the signal tables of analog signals will be adjusted automatically. (Integer: Min / Max; Real: Gain / Offset)

□ **Telegram timebase**

The telegram timebase should be entered here. It determines how fast the data are actually being sent. The received samples will be resampled with respect to this telegram timebase in order to guarantee an equal sample distance in the data file which is needed by ibaAnalyzer.

The telegram timebase should be equal or higher compared to the minimum timebase permitted by the link mode (value in brackets). Smaller values for the telegram timebase will be corrected automatically.

☐ **Checkbox Advanced mode**

If you enable the advanced mode you get more options in terms of data configuration.

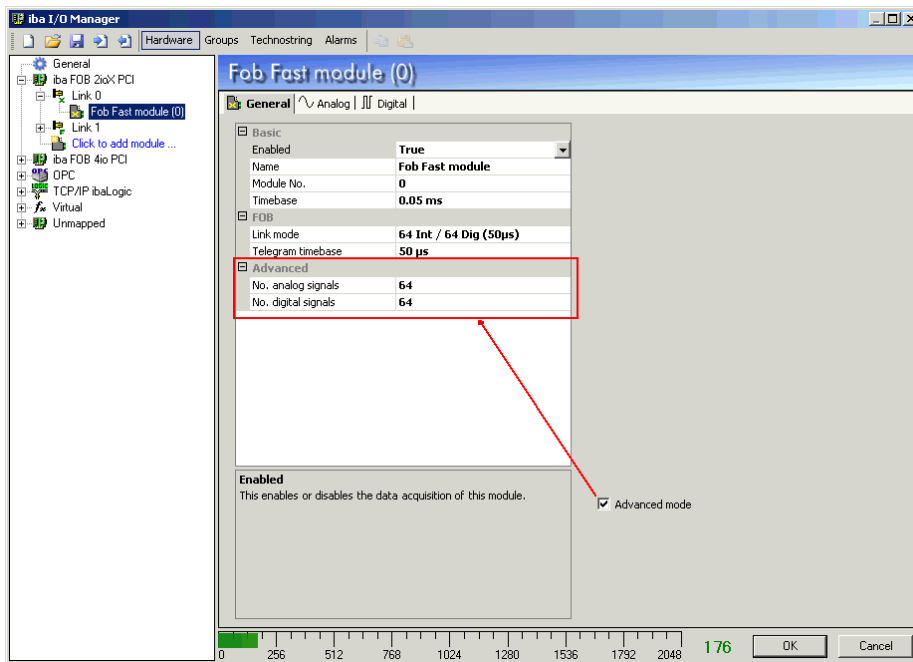

☐ **No. analog- / No. digital signals**

Only available in advanced mode!

These settings permit to specify the number of analog and digital signals to be transmitted as they are configured in the telegram by the data source.

The signal tables for the analog and digital signals will be adjusted automatically.

Moreover, you may specify the position in the telegram and the datatype of each signal in the signal tables.

8.1.3.2. FobFast Module – Signal Tables

The configuration of analog and digital signals is basically to be done in the signal tables as described in section 8.1.2.

But the use of X-mode furthermore offers the advanced mode as described above.

If the advanced mode is enabled the columns Min and Max in the analog signal table are replaced by Gain and Offset columns.

Moreover, you'll find in addition the following columns:

Address

This additional column (together with the column Data Type) allows you to enter the address, i. e. the byte-offset of the signals in the FOB-telegram. The address should be entered as a hexadecimal value. Default setting is 0x40 for analog signals and 0xC0 for digital values. If you want to change the values for an entire column you just need to change the first value and click on the column header. All other values below will be set with respect to the address of the first signal and the data type of the other signals:

- Analog signals in FLOAT-format: in 4 Byte steps
- Analog signals in INT16-format: in 2 Byte steps
- Analog signals in BYTE-format: in 1 Byte steps
- Digital signals in groups of 32 bit: Increase of Bit-no. by 1 through 31. Then increase of address by 4.

For the digital signals you may use a DINT to transmit 32 single bits. You can unpack them by specifying the address and bit no. For the bits in one DINT it's not necessary to enter the address, except for the first one.

Data Type

In each field of this column you can select the data type in use.

Click in a table cell and open the drop-down list.

Available for selection are:

- INT, default, 2 Byte integer
- DINT, 4 Byte integer
- WORD, 2 Byte -value
- DWORD, 4 Byte-value
- BYTE, 1 Byte
- FLOAT, 4 Byte floating point value (real)

It might be necessary to adjust the addresses after a change with respect to the data type.

8.1.4. Diagnosis

The most important diagnostic features are an integrated part of the I/O manager in ibaPDA-V6.

The main branch *General* in the tree view, tab *Interrupt Info*, shows the interrupt counter. The counter iba-Interrupts must have 1000 increments per second! If not, the interrupt master is missing. In this case check the card settings.

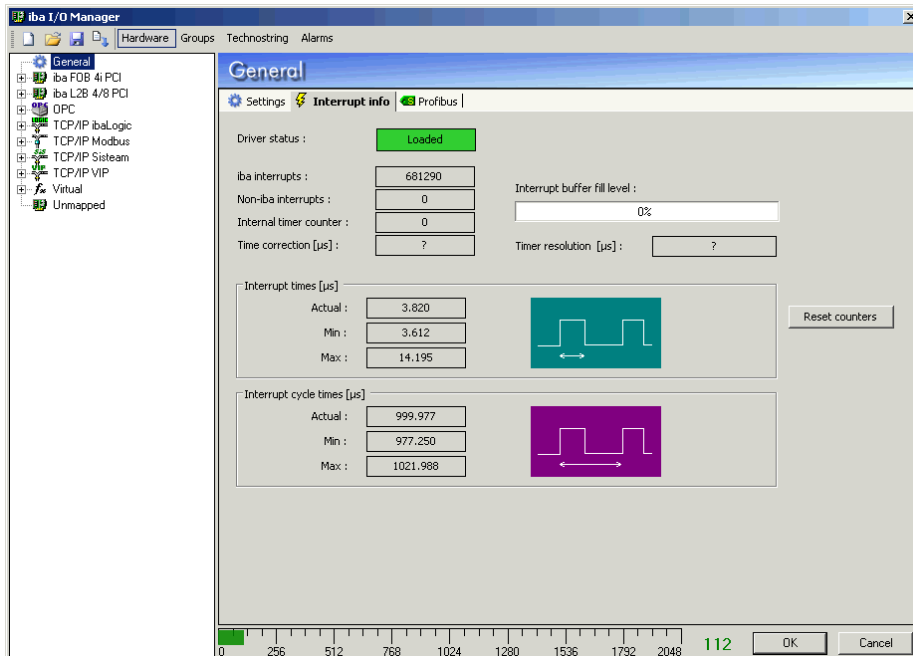

In the dialog box of the link level (see 8.1.1), tab *Info*, you can see if the communication between ibaFOB card and ibaPADU device is working by checking the baud rate value. A stable baud rate means that the communication is working well. An alternating baud rate indicates that the link is broken or the ibaPADU device is off.

When exiting the I/O manager by pressing OK the system performs a consistency check of the configuration. If the configuration is valid it will be applied.



For a detailed description of the system configuration please refer to the corresponding manuals of our software products ibaPDA, ibaLogic or ibaScope.

9 Synchronization of Several Boards

Shut down the computer, remove the power connection and plug in the other iba PCI cards.

Connect the sync-cable between the devices. This is now necessary because the PCI bus does not support any synchronization signal on the bus which is available at all slots simultaneously. The sync line (a 6-pole flat ribbon connector) ensures that all buffers (and data streams) of multiple fiber optic cards are exactly synchronized.

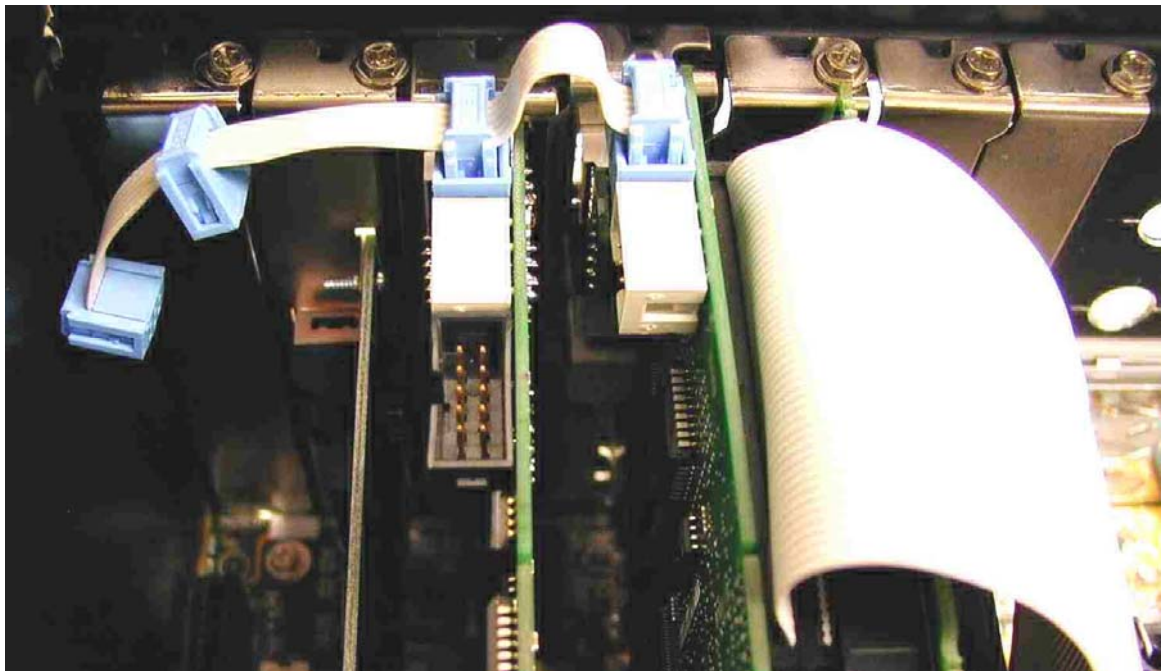

A bad or missing sync-connection may lead to inconsistent data blocks. This would affect the data integrity and data correlation!



Every delivered card comes with a synchronization cable (sync cable) for connecting up to four cards. Unused plugs of the cable can left unconnected and must not be terminated.



Installing additional components may alter your signal configuration (if a system upgrade is made) and interrupt assignments. Save all settings before doing any changes.

Start the PC again, boot Windows and start ibaPDA.

10 Technical Data

Best.-Nr.: ibaFOB-2io-X	11.115500
Best.-Nr.: ibaFOB-4o-X	11.116100
Mechanical:	short PCI card
Operating temperature:	0 °C to 50 °C (32 °F...122 °F)
Storage temperature:	-25 °C to 70 °C (-13 °F...158 °F)
Transport temperature:	-25 °C to 70 °C (-13 °F...158 °F)
Cooling:	air cooled
Power:	via PCI bus
Current consumption:	950 mA max. (without connected modules)
FO-cable	62,5/125 µm
Coupling	ST Lean
Max. distance of fiber optical cable between devices (without repeater)	up to 2000 m (6,560 ft)
Weight (incl. package/documents)	200 g

11 Support and Contact

Support

Phone: +49 911 97282-14
Fax: +49 911 97282-33
E-Mail: support@iba-ag.com



Note

If you require support, specify the serial number (iba-S/N) of the product.

Contact

Headquarters

iba AG
Koenigswarterstr. 44
90762 Fuerth
Germany
Phone: +49 911 97282-0
Fax: +49 911 97282-33
Email: iba@iba-ag.com
Contact: Mr. Harald Opel

Regional and Worldwide

For contact data of your regional iba office or representative please refer to our web site

www.iba-ag.com.