

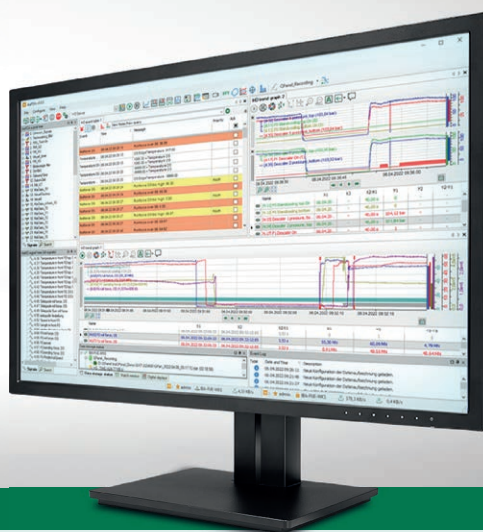

Recording measurement data and events and making them available immediately

ibaHD-Server



ibaHD-Server

Historical data available immediately

Historical data available immediately

ibaHD-Server allows you to continuously record data acquired with ibaPDA. Find events from the past with a mouse click, navigate and zoom quickly from the year, month or week view into the milliseconds range. Use ibaHD-Server to analyze your data over a long period of time and to automatically create day, shift or monthly reports.



At a glance

- ▶ Continuous recording of measured data and events over a long time period
- ▶ Simultaneous recording from several ibaPDA systems and import of measurement files
- ▶ Direct access to historical data with intuitive use for visualization, such as scrolling, jumping to a date
- ▶ Quick zoom function from the annual, monthly or weekly overview down to the range of milliseconds
- ▶ Display and filtering of historical events and joint visualization with measurement data
- ▶ Storage of measurement data and additional information in defined time periods enables the fast analysis of shifts, process steps, etc.
- ▶ Long term analysis of historical data with ibaAnalyzer and ibaDaVIS
- ▶ Automatic calculation of KPIs and automatic reporting with ibaDatCoordinator and ibaAnalyzer
- ▶ API for access to historical data from 3rd party applications

Continuous data recording over long periods of time

Thanks to its ability to store measurement data continuously over long periods of time, ibaHD-Server offers unique opportunities for analysis for different data and requirements as a central and open data platform.

In addition, it is possible to assign measurement data and addition-

al information to defined time periods. Time periods mark a time range that includes, for example, a process section, such as a product change. The time periods function combines the advantages of triggered DAT files with the continuous long-term storage in ibaHD-Server.

Time-based measurement data from ibaPDA can be stored in the ibaHD server not only continu-

ously, but also triggered. This is particularly helpful when very fast, transient processes need to be recorded in a space-saving manner. The start and end triggers of a recording can be configured using the acquired analog and binary signals and their combination and can therefore be perfectly adapted to specific applications.

In addition, configurable events as well as comments and calculated KPIs (Key Performance Indicators) can also be stored in ibaHD-Server. Events, such as the start and end of a production unit, exceeding limit values, etc. can be marked precisely in time and written in the ibaHD-Server. Events can also be used for delimiting and finding certain measurement data. In addition you can also save processed data or calculated characteristic values in the ibaHD-Server together with the events.

Calculated process parameters or product and batch information can be stored as so-called offline events in the event-based HD store.

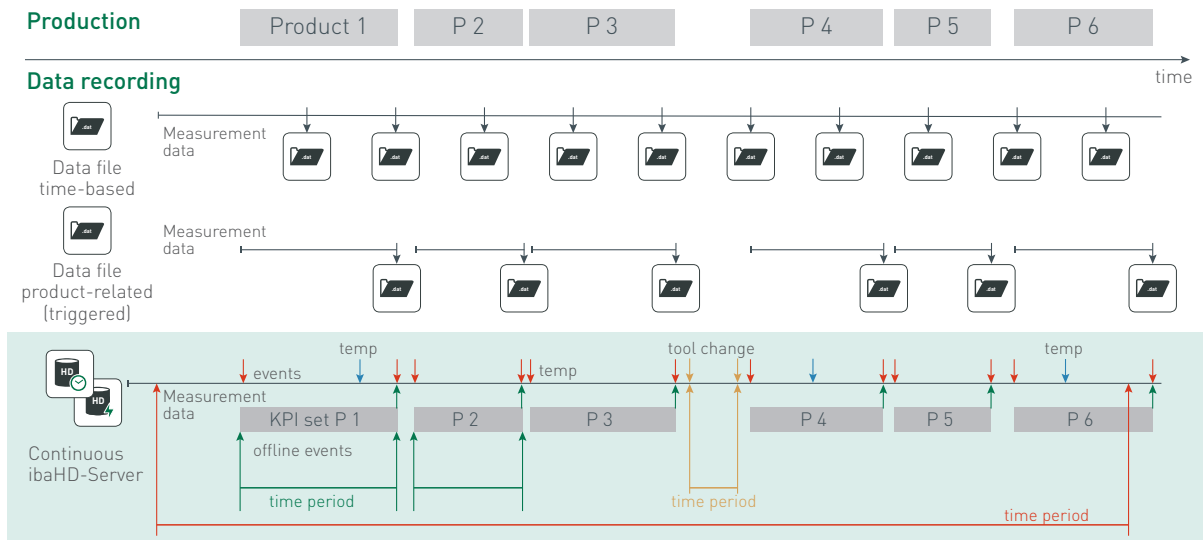

The graphic illustrates the principle of time-based and product-related (triggered) data storage in measurement files, compared to continuous recording with ibaHD-Server. In ibaHD-Server, measurement data, online events and offline events can be stored. The time periods concept combines the advantages of continuous recording with ibaHD-Server and triggered recording of data files.

Global database allows a comprehensive process image

This means that measurement signals from live processes together with values from post-processing are directly available in a global database over a long period of time and open up completely new analysis opportunities.

Since data from the entire plant can be stored centrally from different places and measurement files can be imported from decentral ibaPDA systems, ibaHD-Server also offers a comprehensive image of the processes. You can choose exactly the time periods and measurement data in which you are interested in the displays. For example, several locally recorded plants, machines or components can be visualized and compared together.

Visualization from the annual overview down to the milliseconds range

Thanks to the special storage principle for measurement data in ibaHD-Server, it is possible to display the measured signals over the entire acquisition period in one trend view in the ibaPDA client or in the trend view in ibaAnalyzer.

With a simple zoom function, the displayed time section can be quickly resolved down to months, weeks, days or even milliseconds. Thus, suddenly occurring irregularities in a continuous process can be detected as well as slowly developing trend deviations.

Long-term recording of measurement data with ibaHD-Server offers far-reaching analysis opportunities, for example for maintenance or process technicians, especially in continuous processes such as paper production, product refinement, casting processes or in the energy sector.

Rapid access to events in the past

Messages for product changes or noticeable process conditions can be defined as events and stored in the ibaHD-Server. The events are controlled by trigger conditions and they can be supplemented with information about the current state from text signals or directly from measurement signals from ibaPDA server.

The events are displayed in the ibaPDA client in the filterable event table. By means of targeted queries, e. g. using a keyword search, you can rapidly localize certain events from the past and examine the circumstances in more detail. For example: When did a signal exceed a certain threshold? When was new material fed in? When has a production unit been finished?

If you click on an event in the event table, the associated measurement data and saved videos at the time of the event are immediately shown. The combination of HD trend view

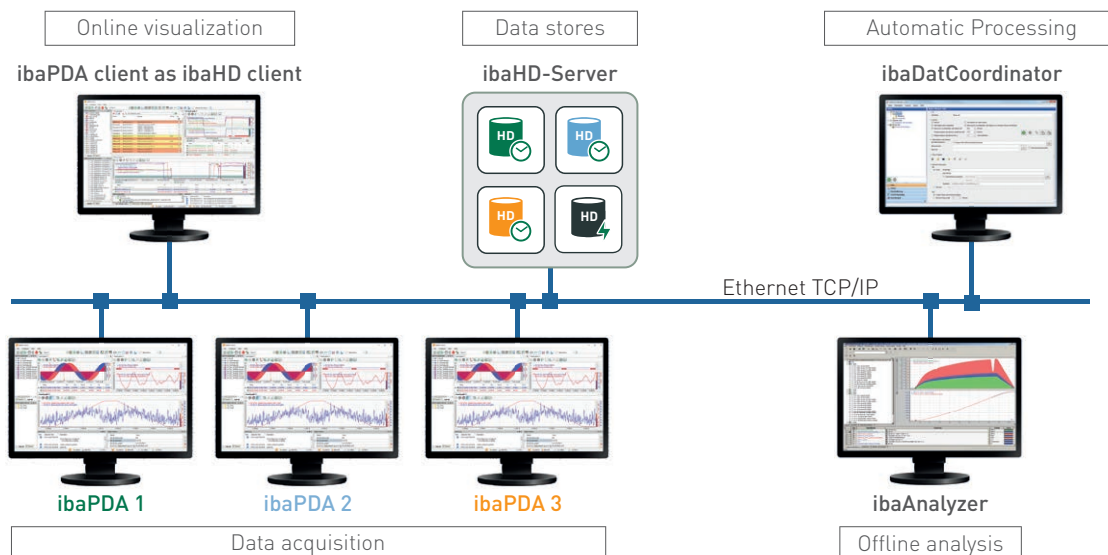

Several ibaPDA servers can write to different HD data stores of an ibaHD-Server.
Event HD data stores can receive data from multiple clients (ibaPDA, ibaDatCoordinator), such as offline events.

and event table provides easy and effective navigation between products or registered process states.

Attach additional information directly at the origin time

Pre-defined or free texts can be placed as annotations in the HD trend view. This means additional information can be documented with the correct time and also supplemented by images, PDF documents or other files.

In the event table, annotations can be displayed, sorted, filtered or searched specifically. The annotations are immediately visible to other users. They facilitate navigation, for example, for commented product changes or the laboratory report submitted subsequently for a particular batch.

Time periods open new possibilities for storage and analysis

Time periods mark a time range within a time-based HD store, such as one process step, one shift, or one day. The start and end of the time periods can be specified using triggers or times.

The processes do not have to be sequential. Time periods can also be applied when products overtake each other during production, such as in the rotary hearth furnace. Unique product identifiers enable the unambiguous assignment to the workpiece. A time period is comparable with a triggered DAT file, but with the signal data that is present in an HD store.

Time periods can be enhanced with info fields to save additional information, such as text signals, KPIs calculated over the

time period, or comments. This enables users to easily access all associated signals of these products or process sections.

The time periods concept combines the advantages of triggered data files with the continuous long-term storage in ibaHD-Server.

Time periods are saved in a database table. The database can either be the internal ibaHD-Server database or an external database provided by the user.

All data for a process step available quickly and at a glance

Time periods are displayed in the ibaPDA client in the time period table that can be filtered. With specific queries, e.g. for certain time ranges or production data, suitable time periods can be found quickly and the associated signals and data can be analyzed efficiently.

Additional information, such as images, comments or reports can be added to the event table.

Measurement signals can be enlarged from the overview of the entire recording period down to the milliseconds range.

By means of several filter functions, you can quickly find events of the past in the event table. Clicking on the event displays the signal trends configured for this purpose at the time of the event.

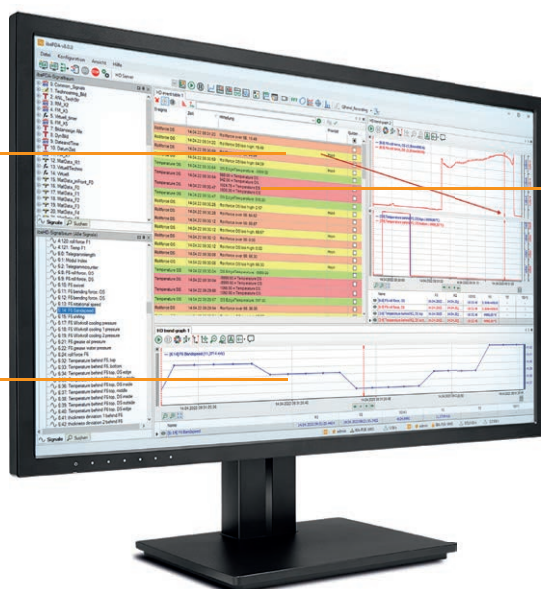

Clicking on a time period in the table immediately displays the measurement data included in it over the entire time period. Process data from different process cycles can thus be displayed and compared very easily.

Video images extend analysis options

The combination of historical data and video images expands the possibilities for analyzing processes or failures. Video images provide additional visual information wherever processes are difficult to measure or cannot be reliably detected by sensors.

Now it is possible to synchronize the recording of historical data with

video recordings in ibaCapture. In ibaAnalyzer, historical data and video sequences can then be viewed and evaluated synchronously - precisely to the sample. As a result, correlations can often be identified more quickly and troubleshooting can be carried out more efficiently.

More than saving data with backups

The backup function offers flexible options for individual backup strategies for HD stores. In this way, the data backup can be automated or manually done according to custom parameters. A full backup includes the entire HD store, while a differential backup includes the last part of the HD store that has not yet been archived.

The backups are primarily used as a backup copy and can be restored if required. However, existing backup data can also be attached to existing HD stores and is then available there for additional analysis.

The data storage in ibaHD-Server complies with the ring storage principle, so that the oldest data is overwritten by new data. An attached backup is not overwritten and can be used as a reference data set for a comparison when replacing legacy systems, for example.

Central management and configuration



Convenient administration with ibaHD-Manager

The ibaHD-Manager is used for diagnostics, administration and configuration of the ibaHD-Server service as a central management tool. It provides status information about the active HD clients and HD stores, such as the number of signals and disk space. In addition, the HD stores can be configured, projects managed, backups created and data files imported in the ibaHD-Manager.

One single server for more than one HD data store

One ibaHD-Server can be used for administrating more than one HD store. Both the time-based and length-based recording of signals as well as the recording of event messages are treated like the recording of a measurement file in ibaPDA. An ibaPDA system can supply several HD stores on the same or on different ibaHD-Servers with data. Likewise, several ibaPDA systems can write their data to the same ibaHD-Server, but in different HD stores. Events from several ibaPDA server systems can be merged in a single event HD data store.

This way, the ibaHD-Server can be used as a higher level sys-

tem for data storage from different plants of one factory.

Simply import data files

Measurement files in DAT format created with ibaPDA can be integrated into an HD store via an import process. For this purpose it is possible to import data files or entire data file directories into an HD store and measurement data can be entered with the correct time.

This means that data files coming from older inventories can be merged into one HD store so that this data can be accessed directly.

In addition, data files can be imported, which were recorded by several independent ibaPDA systems (e. g. with ibaDAQ on cranes or conveyor vehicles). In this way, measurement data from several independent systems can be accessed jointly to visualize the data together, to analyze it or to display the data in a report (shift, day or monthly report).

Using the software ibaDatCoordinator, you can even automate the import of measurement files automatically. ibaDatCoordinator is easy to configure and relieves the user of routine tasks.

User management

To protect the data in ibaHD-Server against unauthorized access, the user management offers the possibility to assign authorizations to individual users. The permissions, for example, concern the configuration of the ibaHD-Server, read and write rights for individual HD stores, configuration of HD stores, creating or restoring backups.

SNMP

ibaHD-Server has an integrated SNMP server and can be integrated into a company-wide network management system according to the SNMP protocol. SNMP protocols V1, V2c and V3 are supported. The SNMP server provides by default information about the license, ibaHD-Server service, HD stores, reading and writing clients as well as backups.

Automatic e-mail messages

Status messages from ibaHD-Server can be sent immediately to defined recipients using the e-mail function. E-mails can be sent automatically by means of predefined trigger signals. Responsible persons can thus react as quickly as possible to events, such as falling below a configurable limit of free storage space.

Tailor-made analyses of HD data

Interactive analysis with ibaAnalyzer

Data from ibaHD-Server can be conveniently retrieved, displayed and analyzed with the ibaAnalyzer analysis program. It is just as easy to access HD data as it is to open a measurement file.

The big advantage of ibaHD-Server is that the aggregated data can be displayed over a larger period of time than is possible with measurement files - for example over a week, a month or even longer period of time.

The data can be easily selected using markers in a preview or directly by specifying the time period. Depending on the time period selected, the matching aggregation level is selected automatically.

You can calculate statistical values over the selected time period as well as identify long-term trends. Despite the aggregation, outliers can also be detected due to the so-called sub-signals minimum and maximum added to each signal in the HD stores. If data is to be examined in detail, e. g. irregularities in a production shift, then

the drill down function ensures that the data is available up to the highest resolution in ibaAnalyzer.

Searching signal conditions

It is also possible to search signal conditions in any given time period and, for example, to find outliers and limit value exceedances. When searching, several conditions can be linked with AND or OR in ibaAnalyzer to search complex conditions as well. It is also possible to search for events and to query event parameters, such as the product number or alarm values.

A practical example is searching for a signal, here the rolling force exceedance, in a specified time

period. All points are displayed as a result where a corresponding rolling force exceedance occurred. The signals and events of the found occurrences can be extracted into measurement files and processed further. The rolling forces of different products can then be superimposed and compared.

License-free offline analysis with backups

Backups generated with ibaHD-Server can be read and analyzed with ibaAnalyzer for free without a license. In this way, you can analyze HD data independently of the productive system. Very long periods of time can also be analyzed with attached backups.

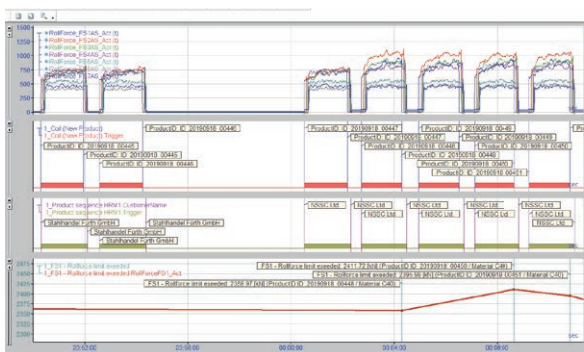
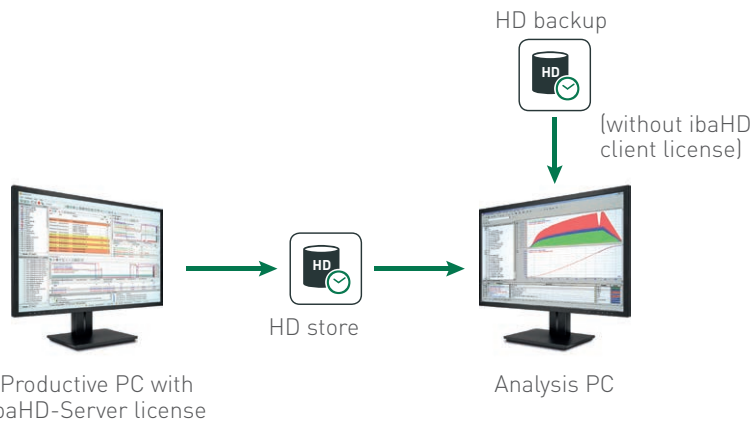

Query of time series and events

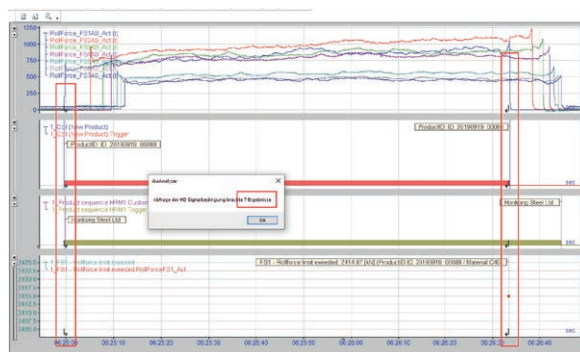

Query when using signal conditions

Automatically post-process HD data and extract information

HD data can be automatically processed with the software ibaDatCoordinator. A time period can be configured in ibaDatCoordinator for which the data from ibaHD-Server is to be read and processed. Based on the HD data, so-called offline events can also be generated or the data can be processed like measurement files, for example to calculate characteristic values (KPIs) and extract these KPIs into databases or to use them in reports.

Generate offline events

The ibaDatCoordinator software can generate so-called offline events during post-processing on the basis of data files or HD data. Calculated process parameters or product and batch information are stored as offline events in the event-based HD store.

The offline events can be displayed, evaluated and used in reports together with the data acquired online with ibaPDA.

ibaHD-Server makes it possible to jointly store high-resolution real-time data and calculated characteristic values that were configured in ibaDatCoordinator.

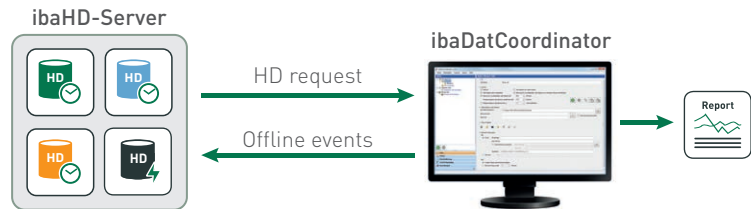

ibaDatCoordinator can be used to save calculated KPIs as so-called offline events in the ibaHD-Server, but HD queries can also be automatically executed.

Automatic characteristic value calculation and reporting

ibaHD-Server offers the major advantage that measurement data can be accessed over a long period of time on a time basis without opening several measurement files, or that only time ranges of a measurement file can be taken into consideration.

Characteristic values can therefore be easily calculated over any configurable periods of time, such as a shift, day, week or month. These

characteristic values can then be loaded into external databases with ibaAnalyzer-DB or used in time-based reports with ibaAnalyzer-Reportgenerator. In this way, automatic reports can be created for a shift, a day or a month, such as energy and consumption reports.

Moreover, reports can also be configured based on HD events. Whenever an event occurs and is saved in ibaHD-Server, an event-based report is automatically created, such as an error report.

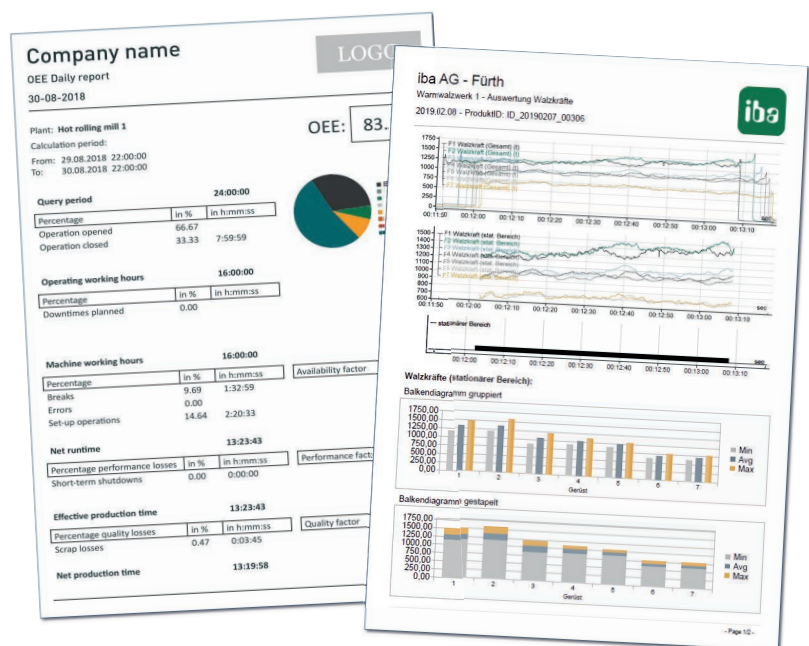

Example of automatically created time-related reports

Open data platform for any type of data analysis

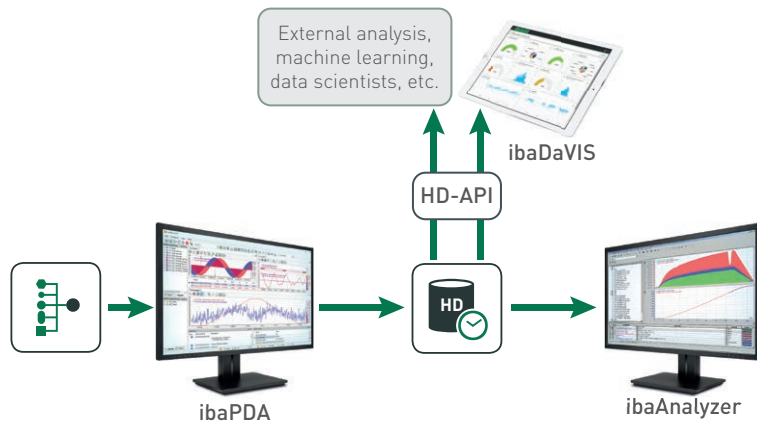

Access to HD data with customer-specific systems

The product ibaHD-Server-V2-API-Read is a programming interface (API: Application Programming Interface) that can be used to query historical data and events from the HD stores by external systems.

The API enables custom systems and users such as data scientists to flexibly read stored signals and events. The database available in ibaHD-Server can thus be used for modeling, machine learning, benchmarking, anomaly detection, etc. It is possible to access exactly those time periods that are needed for the respective requirement.

The programming interface is based on the gRPC framework and offers tools to generate client code for different programming languages, such as Android Java, C# / .NET, C++, Go, Java, Kotlin/JVM, Node.js, Objective-C, PHP, Python. Programming examples for selected languages are available by request.

ibaHD-Server-V2-API-Read is licensed separately. The prerequisite is an ibaHD-Server license. The number of clients connected via the API or the number of queries are not limited.

Analyzing HD data web-based with ibaDaVIS

The programming interface ibaHD-Server-V2-API-Read is used internally at iba to analyze and visualize data from ibaHD-Server in ibaDaVIS. ibaDaVIS makes it possible to visualize and analyze process data and characteristic values in the web browser.

The entire functionality of ibaDaVIS can also be applied on time-based or event-based data from ibaHD-Server. This also requires a license for the API.

Publish data via OPC UA

ibaHD-Server provides an integrated OPC UA server. This means that third-party systems with OPC UA client function can access the data recorded in ibaHD-Server. By default, diagnostic data of ibaHD-Server is provided via OPC UA, such as free or occupied memory space. The license ibaHD-Server-OPC-UA-Server+ is required to read historical data and signals from ibaHD stores.



Event table and trend viewer of HD data in ibaDaVIS

Notes on product concept and computer equipment

Modular Product Design

The basic licenses for ibaHD-Server are graded according to the number of signals and comprise one ibaHD-Server, two HD data stores and two HD clients. One time period can be used with the basic license. A separate license is required for the definition of further time periods. One license allows to define two time periods.

The licensed HD data stores can be used for time-, length- or event-based HD data stores.

For a further extension, licenses are available for further HD data stores (on the same server) and further HD clients which allow the access from several clients to the historical data of an ibaHD-Server. For each workstation that is supposed to display historical data, an ibaHD-Server client license and the ibaPDA client software are necessary.

Virtualized environment and ibaHD-Server

ibaHD-Server can be operated in a virtualized Windows PC. The performance capability of the virtual

machine and the data volume to be processed by the ibaHD-Server must suitably matched to each other. For operating ibaHD-Server in a virtual environment, we recommend licensing as soft license and not via USB dongle. The article "WIBU Software-Key" (60.000007) is needed for the version as soft license.

In principle, it is preferable to use a physical machine for operating ibaHD-Server, because the algorithms for data storage and management are highly optimized regarding the use of dedicated hardware. The hardware can also be better tailored to the requirements of ibaHD-Server.

That is why ibaRackline-PC HD is equipped with an NVMe SSD by default, which can be configured as a so-called intermediate store. This performance does not exist to the same extent if ibaHD-Server is operated in virtualized environments. We can help you to find the right configuration for your tasks.

Requirements:

- › ibaPDA v8.2.0 or higher is required for the use of time periods
- › Operating system: Windows 8.1 or 10 (x86/x64), Windows 11 (x64), Windows Server 2012 R2, 2016, 2019 or 2022 (x64).
- › .NET-Framework 4.8 or higher
- › Analyzing with ibaAnalyzer v7.0.0 or higher
- › Analysis and visualization of HD data with ibaDaVIS v2.8.0 or higher
- › Recommendations for computer equipment can be found on page 11.

i You can find additional information about the computer in the brochure "Powerful industrial PCs, PC connections, FO infrastructure"



ibaRackline-PC HD

Recommendations for operating ibaHD-Server on physical servers or virtual machines

Baseline

- ▶ Operating system: Windows 10 (x86/x64), 11 (x64), Windows Server 2016 (x64), 2019 (x64), 2022 (x64)
- ▶ Processor: 2 core + 1 core per HD data store; > 2 GHz
- ▶ RAM: min. 8 GB + 2 GB per HD data store
- ▶ Intermediate store: Always flash on local machine. No network storage. See the table below for examples of recommended buffer size.

- ▶ ibaHD store: Preferably flash. Local or network drive in RAID.
- ▶ Disk space: depending on number of signals and storage period¹

Maximum ibaHD- Server configuration

(Recommendation for one ibaHD-Server computer)

- ▶ Data storage: max. 32 HD data stores
- ▶ Overall number of signals: max. 32000 signals (all combinations

of analog and digital signals excluding events)

- ▶ Number of signals per time-based HD data store: max. 16000 signals (all combinations of analog and digital signals)
- ▶ Number of signals per event HD data store: max. 16000 events
- ▶ Number of signals per alarms and events HD data store: max. 100000 signals

¹ The given disk storage size are net sizes, this means that the real storage systems should have more capacity to avoid loss of performance related to internal organizational processes

Estimation of storage capacity

Number of signals	Resolution	Occupied storage ²		
		Recording time 24 h	Recording time 7 days	Recording time 30 days
100 analog	100 ms	0.5 GB	3 GB	14 GB
100 analog	10 ms	4.5 GB	31 GB	135 GB
100 analog	1 ms	45 GB	310 GB	1350 GB
100 digital	100 ms	10 MB	50 MB	200 MB
100 digital	10 ms	30 MB	160 MB	660 MB
100 digital	1 ms	100 MB	650 MB	2650 MB
10 events	1 event per second	100 MB (864000 registered events)	780 MB	3 GB

² The values shown here for the occupied storage capacity are synthetically determined. For the estimation, test signals were used that can only be slightly compressed in ibaHD-Server with the compression algorithms. In real operation, the compression algorithms are very effective and far less storage capacity is needed for analog or digital signals.

Recommendations for the size of the intermediate store

Use case 1	
1 time-based HD data store, 1000 signals	50 GB
Use case 2	
2 time-based HD data stores, 1500 signals each	2x 100 GB
+ 3 time-based HD data stores, 2000 signals in total	3x 50 GB
+ 1 event HD data store	50 GB
	<hr style="width: 100px; margin-left: 0;"/> Σ 400 GB

Order information

ibaHD-Server

30.800064	ibaHD-Server-64	Basic license ibaHD-Server for 64 tags (signals), including 2 HD clients, 2 HD stores and 1 time period
30.800128	ibaHD-Server-128	Basic license ibaHD-Server for 128 tags (signals), including 2 HD clients, 2 HD stores and 1 time period
30.800256	ibaHD-Server-256	Basic license ibaHD-Server for 256 tags (signals), including 2 HD clients, 2 HD stores and 1 time period
30.800512	ibaHD-Server-512	Basic license ibaHD-Server for 512 tags (signals), including 2 HD clients, 2 HD stores and 1 time period
30.801024	ibaHD-Server-1024	Basic license ibaHD-Server for 1024 tags (signals), including 2 HD clients, 2 HD stores and 1 time period
30.802048	ibaHD-Server-2048	Basic license ibaHD-Server for 2048 tags (signals), including 2 HD clients, 2 HD stores and 1 time period
30.804096	ibaHD-Server-4096	Basic license ibaHD-Server for 4096 tags (signals), including 2 HD clients, 2 HD stores and 1 time period
30.808192	ibaHD-Server-8192	Basic license ibaHD-Server for 8192 tags (signals), including 2 HD clients, 2 HD stores and 1 time period
30.806666	ibaHD-Server-unlimited	Basic license ibaHD-Server for unlimited number of tags, including 2 HD clients, 2 HD stores ³ and 1 time period
30.800003	ibaHD-Server-One-Store	License extension HD-Server: 1 more HD data store (only with WIBU dongle)
30.800004	ibaHD-Server-Two-Stores	License extension HD-Server: 2 more HD data stores
30.800005	ibaHD-Server-Client	License extension ibaHD-Server: single client
30.800006	ibaHD-Server-Multi Client	License extension ibaHD-Server: 5 additional HD client interfaces
30.800007	ibaHD-Server-OPC-UA-Server+	License extension for extended OPC UA server functionality
30.800010	ibaHD-Server Time Period	License extension for the definition of 2 time periods
30.800011	ibaHD-Server Ultra Time Period Store	License extension for the definition of 128 time periods
30.820001	Upgrade-HD-Server-64 to 128	License extension ibaHD-Server: 64 tags to 128 tags
30.820002	Upgrade-HD-Server-128 to 256	License extension ibaHD-Server: 128 tags to 256 tags
30.820003	Upgrade-HD-Server-256 to 512	License extension ibaHD-Server: 256 tags to 512 tags
30.820004	Upgrade-HD-Server-512 to 1024	License extension ibaHD-Server: 512 tags to 1024 tags
30.820005	Upgrade-HD-Server-1024 to 2048	License extension ibaHD-Server: 1024 tags to 2048 tags
30.820006	Upgrade-HD-Server-2048 to 4096	License extension ibaHD-Server: 2048 tags to 4096 tags
30.820007	Upgrade-HD-Server-4096 to 8192	License extension ibaHD-Server: 4096 tags to 8192 tags
30.820008	Upgrade-HD-Server-8192 to unlimited	License extension ibaHD-Server: 8192 tags to unlimited tags
30.800001	ibaHD-Server-API-Read	gRPC-API interface to query saved signals and events from existing HD stores
60.000007	WIBU Software-Key	Generating a software key

³ The number of tags that can be stored per HD store is limited to 65534.

The upgrade licenses 30.820001 to 30.820008 are supported from ibaHD-Server v3.0.0.

Computer system

40.005031	ibaRackline-PC HD, XEON E, Win10	ibaRackline for measurement data recording
19.000012	Dongle server Pro	USB dongle server

Training

61.100000	Measuring, analyzing and automatic reporting with iba	3-day compact course
61.000200	Measuring and analyzing with the iba system	2-day basic course
61.000400	Long-term acquisition of data and events using ibaHD-Server	2-day advanced course



Headquarters Germany

iba AG

Office address

Koenigswarterstr. 44
D-90762 Fuerth

Mailing address

P.O. box 1828
D-90708 Fuerth
Tel.: +49 (911) 97282-0
www.iba-ag.com
info@iba-ag.com

Europe

iba Austria GmbH

Austria & Hungary
order@iba-austria.at

iba Benelux BV

Belgium, the Netherlands, Luxembourg,
France, Ireland, Great Britain,
French-speaking Switzerland
sales@iba-benelux.com

iba Czechia

Czechia, Slovakia
josef.dusek@compas.cz

iba Ibérica

Spain, Portugal
sales@iba-iberica.com

iba Italia S.R.L.

Italy, Slovenia, Croatia, Serbia,
Italian-speaking Switzerland
sales@iba-italia.com

iba Nordic

Denmark, Finland, Norway, Sweden
c/o Begner Agenturer AB
info@begner.com

iba Polska

c/o ADEGIS Sp. z o.o. Sp.k.
support@iba-polska.com

000 iba Russia

dmitry.rubanov@iba-russia.com

Asia

iba Asia GmbH & Co. KG

Western and Central Asia, Philippines,
Cambodia, Laos, Myanmar, Bhutan, Nepal
henry.regn@iba-asia.com

iba China Ltd.

julia.wang@iba-china.com

iba Gulf

Saudi Arabia, UAE, Qatar,
Kuwait, Bahrain and Oman
c/o ASM
a.magboul@iba-gulf.com

iba Indonesia

c/o PT. Indahjaya Ekaperkasa
sandhi.sugiarto@iba-indonesia.com

iba Korea System Co. Ltd.

Japan
hj.park@ibakorea.co.kr

iba Korea System Co. Ltd.

Korea
sh.lee@ibakorea.co.kr

iba Malaysia

c/o iba Engineering & Consulting
(Malaysia) SDN. BHD
bruno.marot@iba-malaysia.com

iba Singapore

c/o iba (S.E.A.) Engineering &
Consulting Pte. Ltd.
bruno.marot@iba-sea.com

iba Systems India Pvt. Ltd.

India, Bangladesh, Nepal, Pakistan, Sri Lanka
shraddhap@iba-india.com

iba Thailand

c/o SOLCO Siam Co. Ltd.
pairote@iba-thai.com

iba Turkey Ltd.

ahmet@iba-turkey.com

iba Vietnam

c/o Tang Minh Phat Co., Ltd
sales@iba-vietnam.com

Australia and Oceania

iba Oceania Systems Pty Ltd.

Australia, New Zealand, PNG, Micronesia and
South Pacific Islands (except US territories)
fritz.woller@iba-oceania.com

Central and South America

iba LAT, S.A.

iba@iba-lat.com

iba LAT Argentina

iba@iba-argentina.com

iba LAT Bolivia

iba@iba-bolivia.com

iba Brasil

iba@iba-brasil.com

iba Chile

iba@iba-chile.com

North America (USMCA)

iba America, LLC

USA
esnyder@iba-america.com

iba America, LLC

Canada
dkober@iba-america.com

iba America, LLC

Mexico
jgiraldo@iba-america.com

Africa

iba Benelux BV

Maghreb (Morocco, Algeria, Tunisia), Senegal
sales@iba-benelux.com

iba Africa

South Africa
c/o Variable Speed Systems cc
danie@iba-africa.com

iba AG is represented worldwide by
subsidiaries and sales partners.
Technical changes and errors excepted.